

# Simulation Study of Microwave Microplasmas based on Microstrip Technology

Lizhu Tong

*Keisoku Engineering System Co., Ltd., Japan*

*October 15, 2015*

# Research Backgrounds (1)

- The generation of stable plasmas can be easily done using microwave generators. A large number of chemical processes make use of such plasma sources.
- The physics of a microwave plasma is quite different depending on whether the TE mode (out-of-plane electric field) or the TM mode (in-plane electric field) is propagating. In both cases it is not possible for the electromagnetic wave to penetrate into regions of the plasma where the electron density exceeds the critical electron density (around  $7.6 \times 10^{16} / \text{m}^3$  for argon at 2.45 GHz).
- The pressure range for microwave plasmas is very broad. For electron cyclotron resonance (ECR) plasmas, the pressure can be on the order of 1 Pa or less. For non-ECR plasmas the pressure typically ranges from 100 Pa up to atmospheric pressure.
- The power can range from a few watts to several kilowatts. Microwave plasmas are popular due to the cheap availability of microwave power.

## Research Backgrounds (2)

- Microstrip microplasmas utilize the microstrip technology to transfer electromagnetic fields into a small gas gap in order to generate microplasma.
- A typical schematic diagram of a split-ring resonator microplasma source is shown in the right figure.
- A low-power microwave plasma device based on a metallic wave-guiding structure on a fused-silica wafer with a small gas channel inside is shown as follows

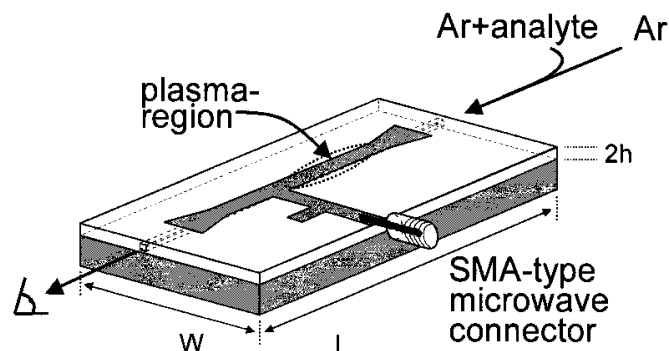

- 1) U. Engel, et al., *Anal. Chem.* **72**, 2000, 193.
- 2) A.M. Bilgic, et al., *Plasma Sources Sci. Technol.* **9**, 2000, 1.

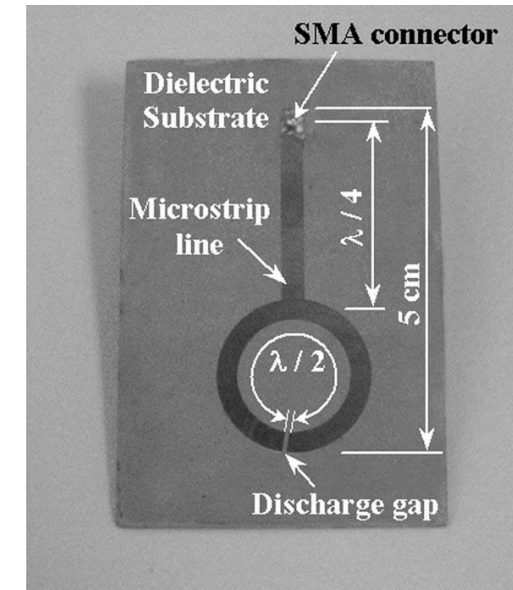

- 1) F. Iza and J.A. Hopwood, *IEEE Trans. Plasma Sci.* **31**(4), 2003, 782.
- 2) A.R. Hoskinson, et al., *J. Anal. At. Spectrom.* **26**, 2011, 1258.

## Research Backgrounds (3)

- An atmospheric-pressure air microplasma structure is shown in the right figure, which consists of a dielectric plate, a stripline, a ground plane, and a small discharge gap for producing plasmas.
- A planar transmission line configuration, corresponding to linear resonators is shown as follows.

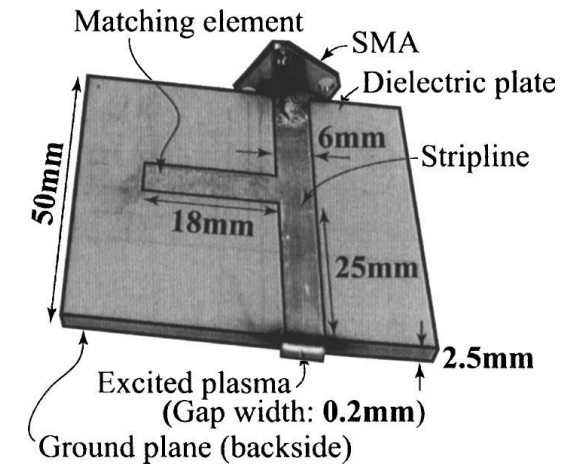

1) J. Kim and K. Terashima, *Appl. Phys. Lett.* **86**, 2005, 191504.

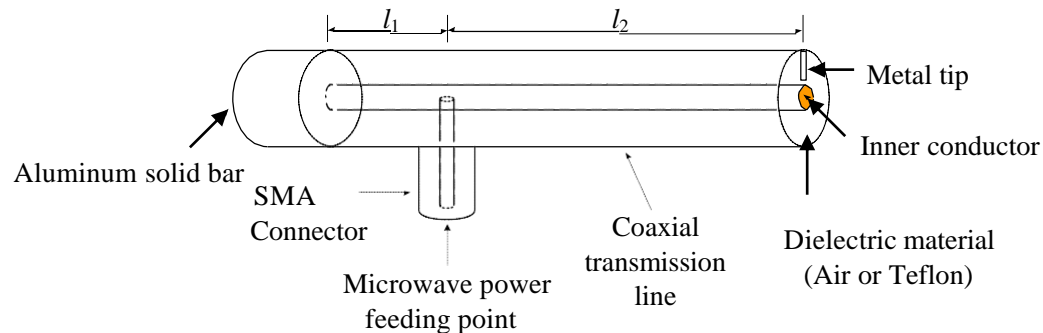

1) J. Choi, et al., *Plasma Sources Sci. Technol.* **18**, 2009, 025029.

2) J. Gregório, et al., *Eur. Phys. J. D* **60**, 2010, 627.

## Research Backgrounds (4)

- When the plasma density is equal to the critical electron density, the electromagnetic wave transitions from being propagating to evanescent within a resonance zone. The critical electron density is given by the formula:

$$n_e = \frac{\epsilon_0 m_e \omega^2}{e^2}$$

- At a frequency of 2.45 GHz, this corresponds to an electron density of  $7.6 \times 10^{16} /\text{m}^3$ , which is lower than most industrial applications.

High-density 3D microwave microstrip plasmas ← ***This work***

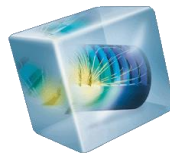
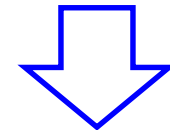

# Computational Method by using COMSOL (1)

- The plasma characteristics on the microwave time scale are separated from the longer term plasma behavior, which is governed by the ambipolar fields.

Maxwell's equations

$$\nabla \times \mathbf{E} = -\frac{\partial \mathbf{B}}{\partial t}$$

$$\nabla \times \mathbf{H} = \mathbf{J}_p + \frac{\partial \mathbf{D}}{\partial t}$$

*Plasma current density*

$$\mathbf{J}_p = \sigma \mathbf{E}$$

Plasma conductivity

$$\sigma = \frac{n_e e^2}{m_e (\nu_m + j\omega)}$$

- In the Plasma Module, the electromagnetic waves are computed in the Frequency Domain.

$$\nabla \times \mu^{-1} \nabla \times \mathbf{E} = (\omega^2 \epsilon_0 \epsilon_r - j\omega\sigma) \mathbf{E}$$

## Computational Method by using COMSOL (2)

- The power transferred from the electromagnetic fields to the electrons is calculated by

$$Q_{rh} = \frac{1}{2} \text{real}(\mathbf{J} \cdot \mathbf{E}^*)$$

- In addition to the electromagnetic waves, the electron density, electron energy density, plasma potential, ionic and neutral species as well as electric field are solved in the Time Domain.

Electron transport

$$\frac{\partial}{\partial t}(n_e) + \nabla \cdot \Gamma_e = R_e$$

$$\frac{\partial}{\partial t}(n_\varepsilon) + \nabla \cdot \Gamma_\varepsilon + \mathbf{E} \cdot \Gamma_e = R_\varepsilon$$

$$\Gamma_e = -n_e(\mu_e \mathbf{E}) - D_e \nabla n_e$$

$$\Gamma_\varepsilon = -n_\varepsilon(\mu_\varepsilon \mathbf{E}) - D_\varepsilon \nabla n_\varepsilon$$

Source term

$$R_e = \sum_{j=1}^M x_j k_j N_n n_e$$

$$R_\varepsilon = \sum_{j=1}^P x_j k_j N_n n_e \Delta \varepsilon_j$$

# Computational Method by using COMSOL (3)

Reaction rate  $k_j = \gamma \int_0^\infty \varepsilon \sigma_j(\varepsilon) f(\varepsilon) d\varepsilon$      $\gamma = (2q/m)^{1/2}$

↙  
Cross sections for electron collisions

- Modified Maxwell-Stefan equation for ion and neutral species

$$\rho \frac{\partial}{\partial t} (w_k) + \rho (\mathbf{u} \cdot \nabla) w_k = \nabla \cdot \mathbf{j}_k + R_k$$

$$\mathbf{j}_k = \rho \omega_k \mathbf{v}_k$$

$$\mathbf{v}_k = \sum_{j=1}^Q \tilde{D}_{kj} \mathbf{d}_k - \frac{D_k^T}{\rho \omega_k} \nabla \ln T$$

$$\mathbf{d}_k = \frac{1}{cRT} \left[ \nabla p_k - \omega_k \nabla p - \rho_k \mathbf{g}_k + \omega_k \sum_{j=1}^Q \rho_j \mathbf{g}_j \right]$$

- Poisson's equation is solved in order to compute the ambipolar electric field generated by the separation of charges:

$$-\nabla \cdot \varepsilon_0 \varepsilon_r \nabla V = \rho$$

$$\rho = q \left( \sum_{k=1}^N Z_k n_k - n_e \right)$$



# Computational Method by using COMSOL (4)

- In the TE mode, the high frequency electric field only contains an out-of-plane component and electrons do not experience any change in the high frequency electric field during the microwave time scale.
- The TM/TEM mode causes in-plane motion of the electrons on the microwave time scale, so in regions where the high frequency electric field is significant, this destroys the phase coherence between the electrons and the fields, causing the electrons to gain energy.

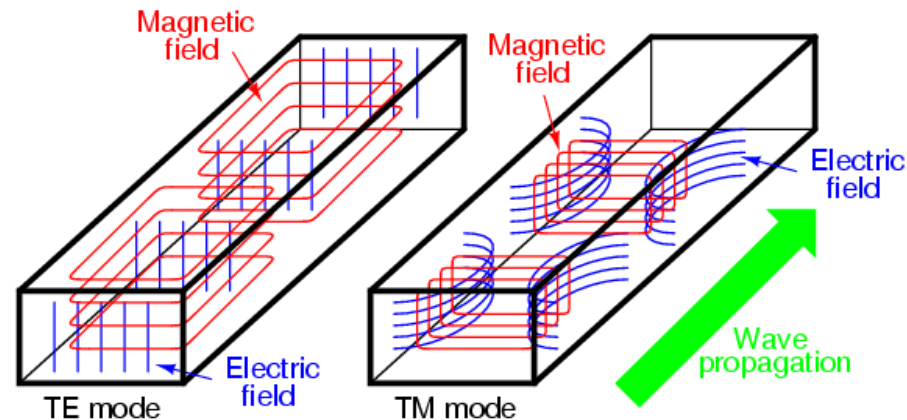

*Magnetic flux lines appear as continuous loops*  
*Electric flux lines appear with beginning and end points*

# Computational Method by using COMSOL (5)

- The resonance zone that the electromagnetic wave transitions from being propagating to evanescent, can be smoothed by activating the Compute tensor plasma conductivity checkbox in the Plasma Properties section:

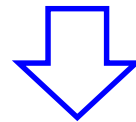

The Doppler broadening parameter

$$\nu_m = \nu_e + \nu_{\text{eff}}$$



The effective collision frequency

$$\nu_{\text{eff}} = \omega / \delta$$

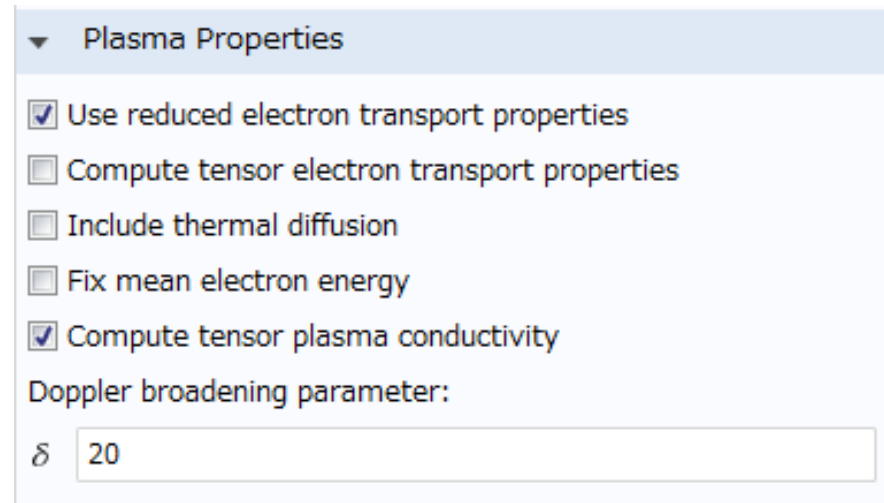

# 3D Model of Microwave Microstrip Plasma Source (1)

- Based on the microstrip technology, the microwave power can be directed to the target area precisely, so as to allow the generation of high-density plasmas and reduce the contamination of the plasma source by sputtering electrodes.

## Computational conditions:

- Gases : Argon
- Species:  $e^-$ , Ar,  $Ar^+$ ,  $Ar_2^+$ ,  $Ar^*$ ,  $Ar_2^*$
- Microwave frequency: 2.45 GHz
- Input power: 2 W
- Temperature: 300 K
- Gas pressure: 50, 100 Torr
- Diameter of gas channel: 0.9 mm
- The effective collision frequency:  $\omega/20$

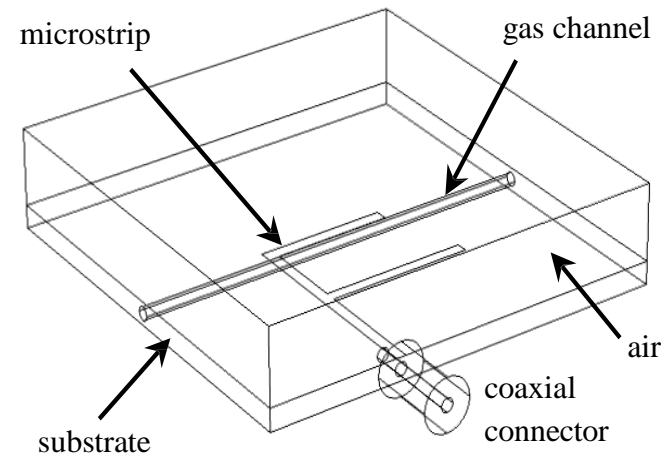

1) A.M. Bilgiç, et al *J. Anal. At. Spectrom.*  
**15**, 2000, 579.

# 3D Model of Microwave Microstrip Plasma Source (2)

## Chemical reactions in the model

No.	Reaction	Reaction type	Reaction rate ( $\text{cm}^3 \cdot \text{s}^{-1} / \text{cm}^6 \cdot \text{s}^{-1} / \text{s}^{-1}$ )
1	$e^- + \text{Ar} \rightarrow e^- + \text{Ar}$	Elastic scattering	$\sigma$
2	$e^- + \text{Ar} \rightarrow e^- + \text{Ar}^*$	Excitation	$\sigma$
3	$e^- + \text{Ar} \rightarrow 2e^- + \text{Ar}^+$	Ionization	$\sigma$
4	$e^- + \text{Ar}^* \rightarrow 2e^- + \text{Ar}^+$	Step-wise Ionization	$\sigma$
5	$e^- + \text{Ar}^* \rightarrow e^- + \text{Ar}$	Metastable quenching	$\sigma$
6	$e^- + \text{Ar}^+ \rightarrow \text{Ar}^*$	Recombination	$4.0 \times 10^{-13} T_e^{-0.5}$
7	$2e^- + \text{Ar}^+ \rightarrow \text{Ar}^* + e^-$	Recombination	$5.0 \times 10^{-27} T_e^{-4.5}$
8	$e^- + \text{Ar}_2^+ \rightarrow \text{Ar}^* + \text{Ar}$	Recombination	$5.38 \times 10^{-8} T_e^{-0.66}$
9	$2\text{Ar}^* \rightarrow \text{Ar}^+ + \text{Ar} + e^-$	Penning ionization	$5.0 \times 10^{-10}$
10	$2\text{Ar}_2^* \rightarrow \text{Ar}_2^+ + 2\text{Ar} + e^-$	Penning ionization	$5.0 \times 10^{-10}$
11	$\text{Ar}^* + 2\text{Ar} \rightarrow \text{Ar}_2^* + \text{Ar}$	Excitation transfer	$1.14 \times 10^{-32}$
12	$\text{Ar}^+ + 2\text{Ar} \rightarrow \text{Ar}_2^+ + \text{Ar}$	Charge exchange	$2.5 \times 10^{-31}$
13	$\text{Ar}_2^* \rightarrow 2\text{Ar}$	De-excitation	$6.0 \times 10^7$
14	$e^- + \text{Ar}_2^* \rightarrow 2e^- + \text{Ar}_2^+$	Step-wise Ionization	$9.0 \times 10^{-8} T_e^{0.7} \exp(-3.66/T_e)$
15	$e^- + \text{Ar}_2^* \rightarrow e^- + 2\text{Ar}$	De-excitation	$10^{-7}$

# 3D Model of Microwave Microstrip Plasma Source (3)

### Electric field

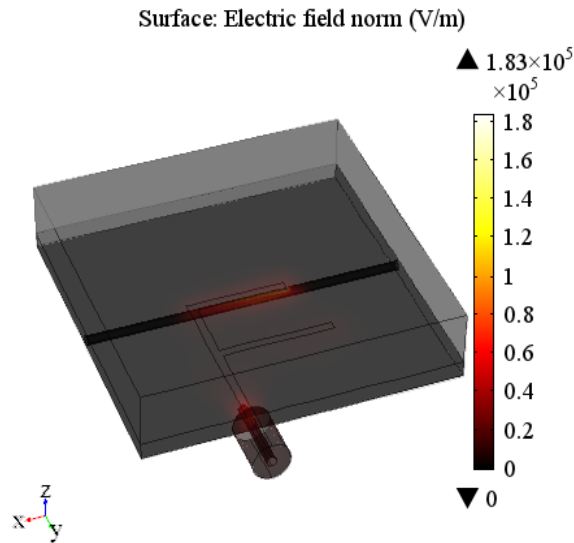

Gas pressure: 50 Torr

### Electron density

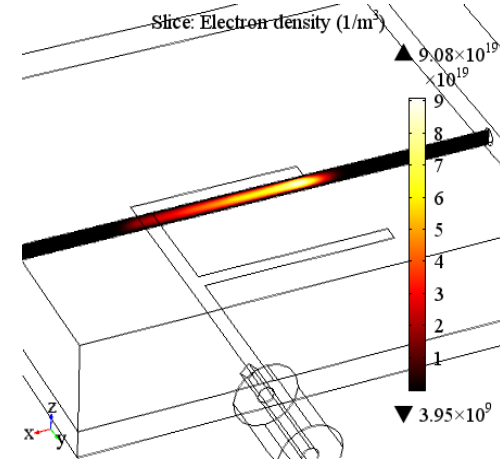

### Electron temperature

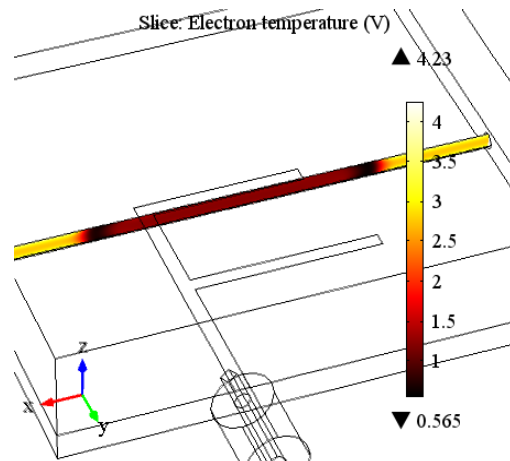

### Electric potential

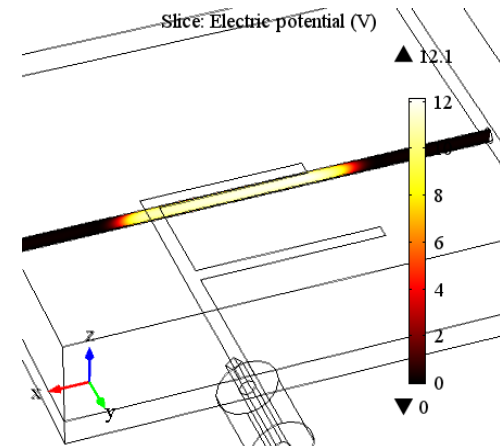

# 3D Model of Microwave Microstrip Plasma Source (4)

Gas pressure: 50 Torr

Argon ion density

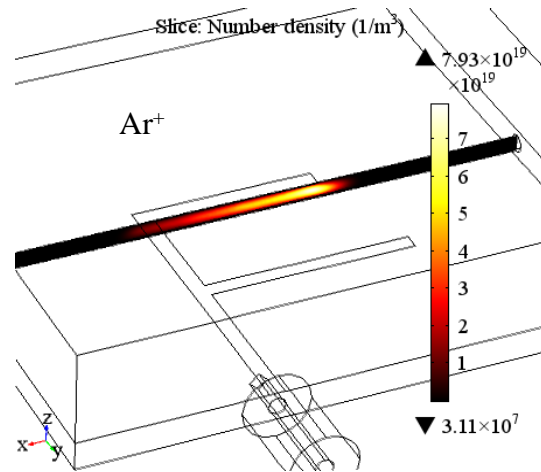

Argon ion density

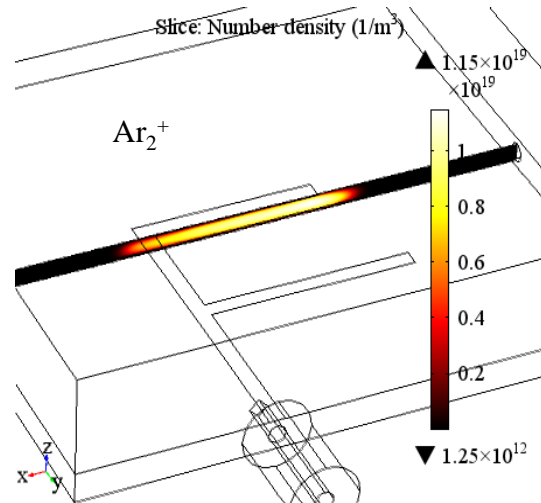

Electrical conductivity

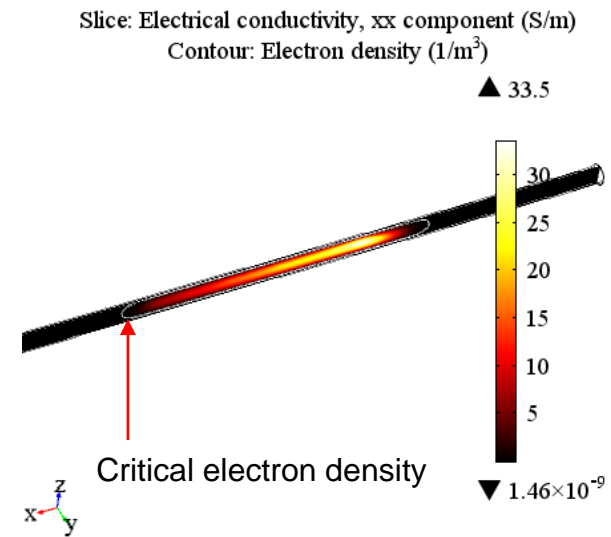

# 3D Model of Microwave Microstrip Plasma Source (5)

Gas pressure: 50 Torr

Excited argon density

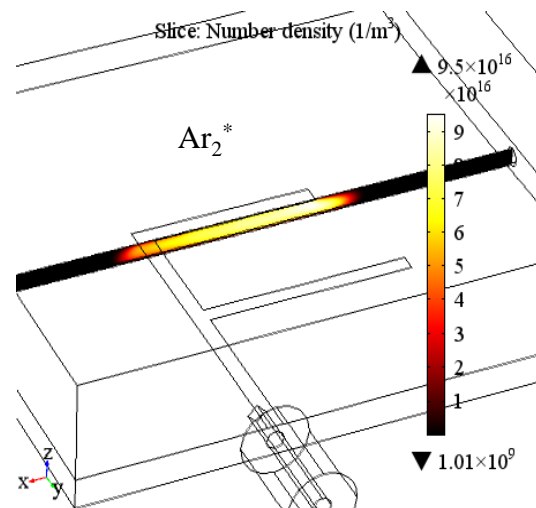
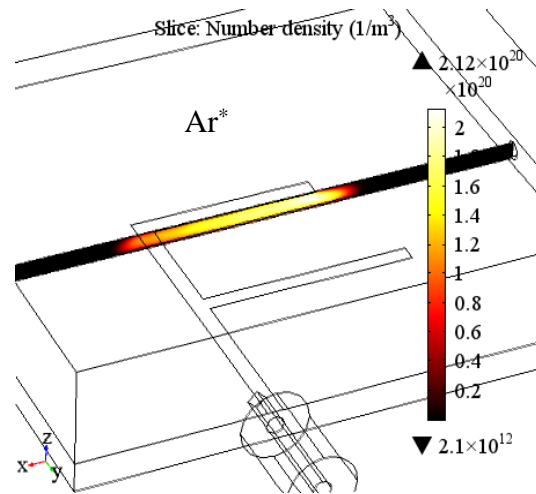

Collisional power loss

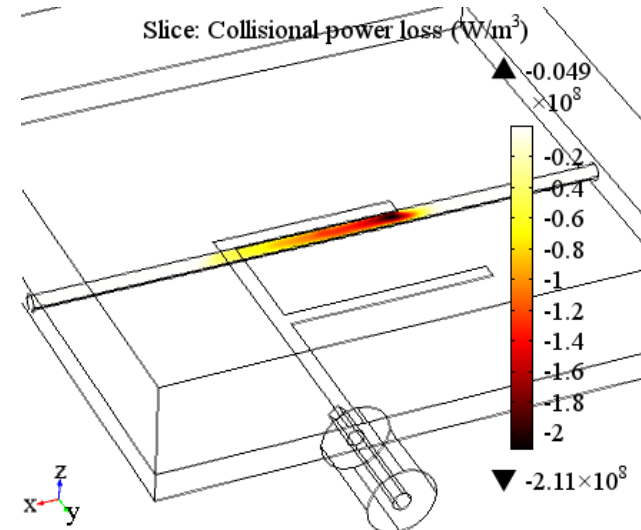

# 3D Model of Microwave Microstrip Plasma Source (6)

Electric field

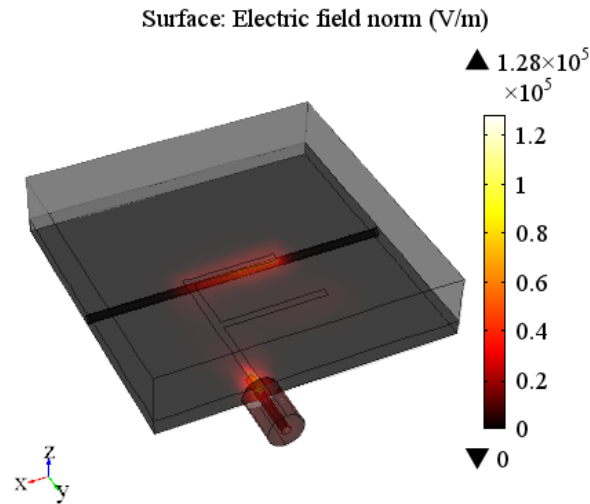

Gas pressure: 100 Torr

Electron density

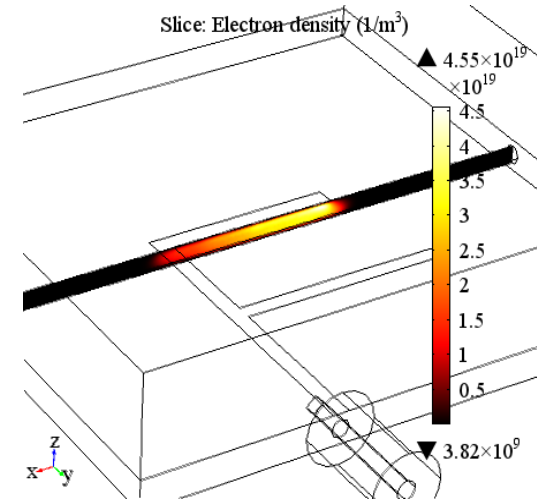

Electron temperature

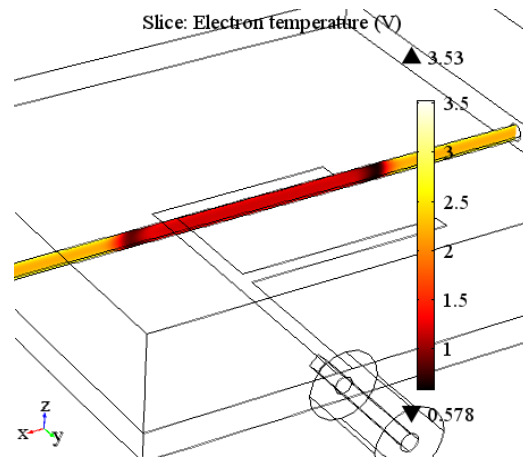

Electric potential

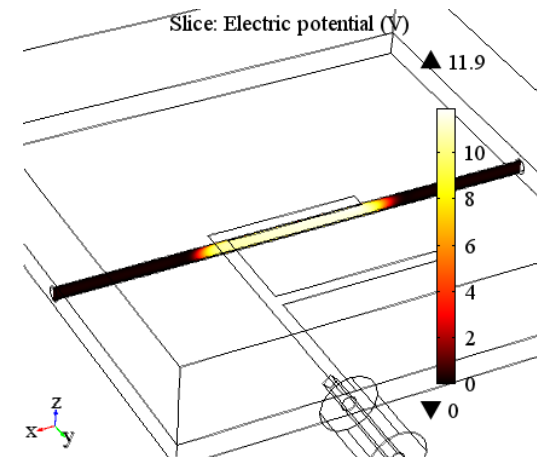



# 3D Model of Microwave Microstrip Plasma Source (7)

Gas pressure: 100 Torr

Argon ion density

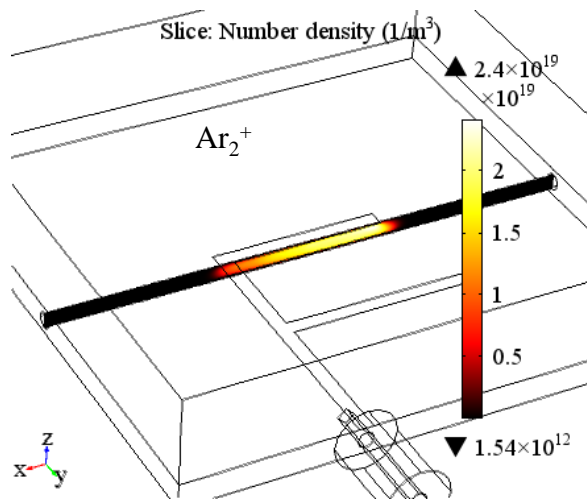
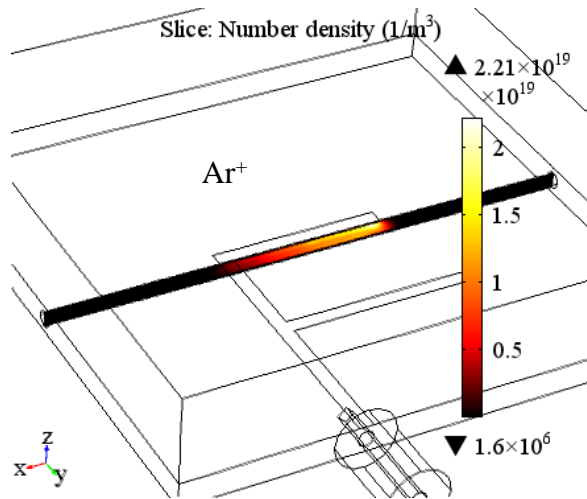

Electrical conductivity

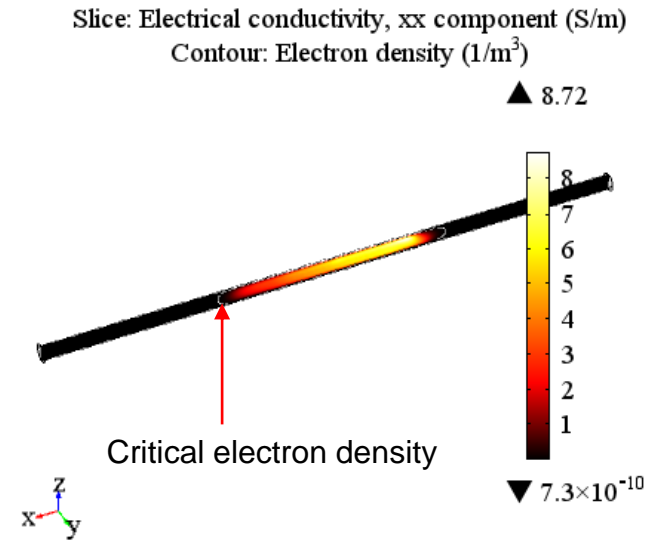

# Conclusions

- This paper presents a three-dimensional fluid model for a low-power microwave-excited argon microstrip plasma source operated at 2.45 GHz.
- The resonance zone at which the electron density is equal to the critical density is solved by adding an effective collision frequency to the momentum collision frequency.
- It is shown that the microwave power is directed to the gas channel. The electric field induced by the electromagnetic wave is concentrated in the neighborhood of the inner surface of gas channel under the microstrip line.
- The governed ions are atomic argon ions ( $\text{Ar}^+$ ) and molecular argon ions ( $\text{Ar}_2^+$ ) and the latter has a wider distribution.
- The model proposed in this work is expected to have the potentiality to develop various microwave-excited microstrip plasma sources.

**Thank you for your attention !**



***Questions & Comments ?***