

Mixing of Liquids in Microfluidic Devices

Bruce A. Finlayson

Professor Emeritus of Chemical Engineering

University of Washington

and Andy Aditya, Vann Brasher, Lisa Dahl, Ha Quan Dinh, Adam Field, Jordan Flynn, Curtis Jenssen, Daniel Kress, Anna Moon, Francis Ninh, Andrew Nordmeier, Ho Hack Song, and Cindy Yuen

Comsol 2008, Boston, October 10, 2008

How to measure the quality of mixing

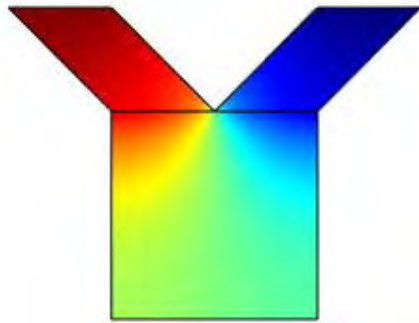

$$c_{\text{mixing cup avg}} = \frac{\int c \mathbf{u} \cdot d\mathbf{A}}{\int \mathbf{u} \cdot d\mathbf{A}}$$

Mixing cup average concentration;

$$\sigma_{\text{mixing cup}}^2 = \frac{\int [c - c_{\text{mixing cup avg}}]^2 \mathbf{u} \cdot d\mathbf{A}}{\int \mathbf{u} \cdot d\mathbf{A}}$$

variance from average

Optical average and optical variance are the same formulae without the velocity - pertinent to measurement via fluorescence

Variance

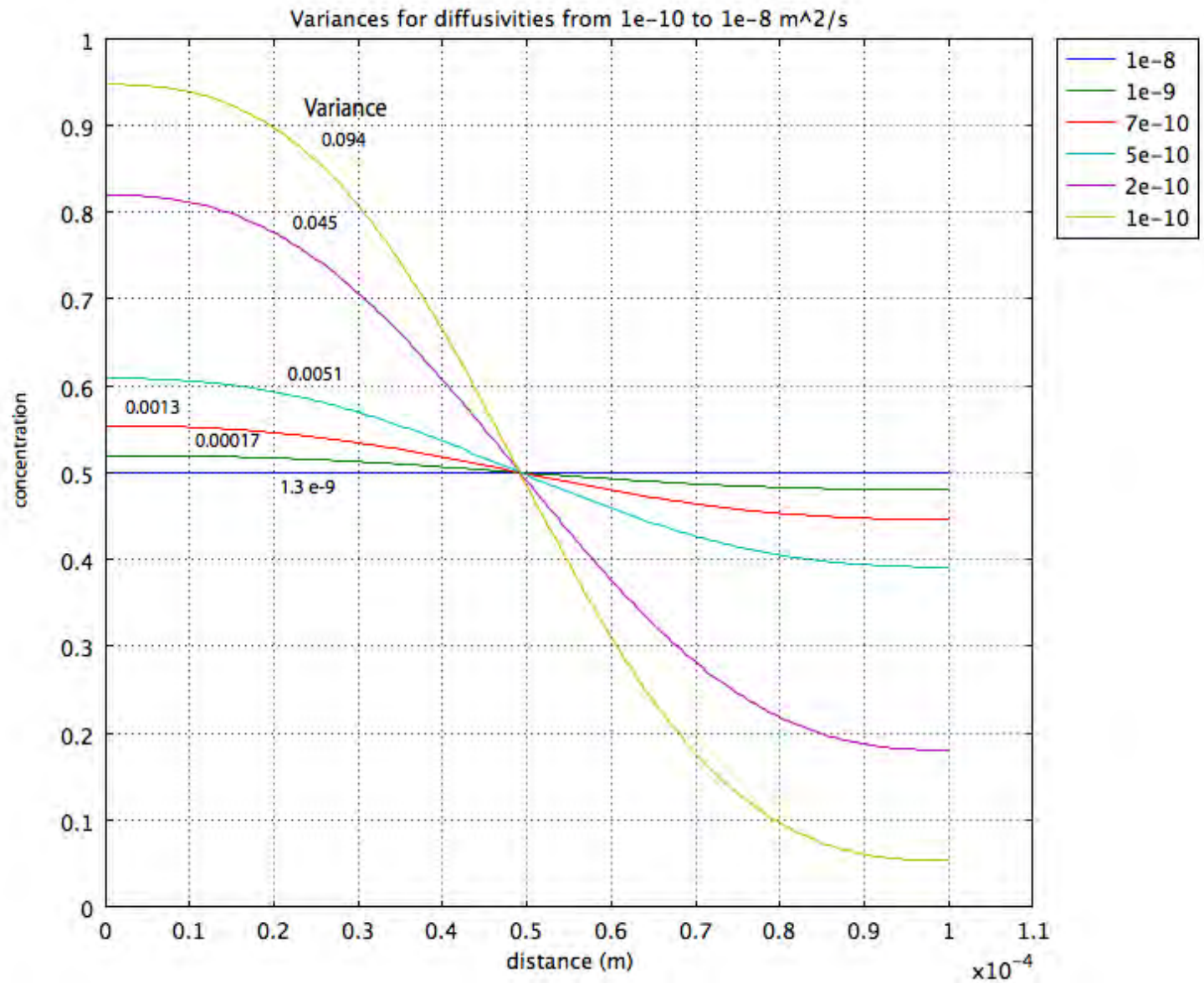

Equations

$$Re = \frac{\rho u_s x_s}{\eta} = 1$$

$$Pe = \frac{u_s x_s}{D} = 1 - 1000$$

$$\mathbf{u} \cdot \nabla \mathbf{u} = -\nabla p' + \frac{1}{Re} \nabla^2 \mathbf{u}$$

$$\mathbf{u} \cdot \nabla c = \frac{1}{Pe} \nabla^2 c$$

Navier-Stokes Equation Convective Diffusion Equation

$$u_s = 0.005 \text{ m/s}, \quad x_s = 200 \text{ } \mu\text{m}, \quad \rho = 1000 \text{ kg/m}^3$$

$$\eta = 0.001 \text{ Pa s}, \quad D = 10^{-9} \text{ m}^2/\text{s} \text{ for } Pe = 1000$$

$$Q = 100 \text{ nL/s}$$

Characterize Mixers

Flow is laminar and slow - inertial effects are not important (Reynolds number $< 1-10$)

Mixers are passive - no mechanical stirrers

Perform the same characterization on all mixers

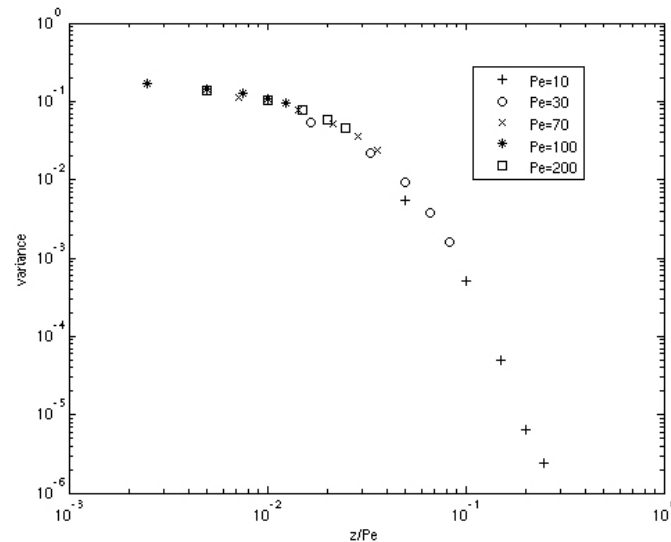
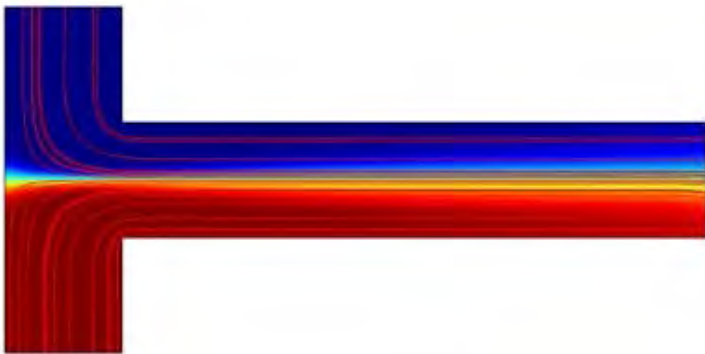

From Ref. 6, using different definitions,

Ref. 6: "Micro-component flow characterization," in *Micro-Instrumentation*, Koch, Vanden Bussche,

Chrisman (ed.), Wiley (2007).

Same curve holds in 2D and 3D

Daniel Kress, Sp, 2007

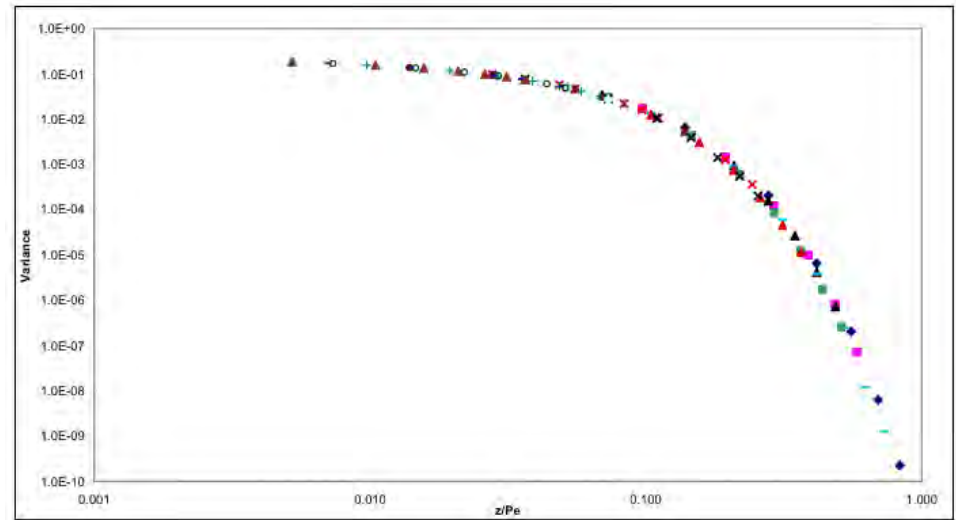
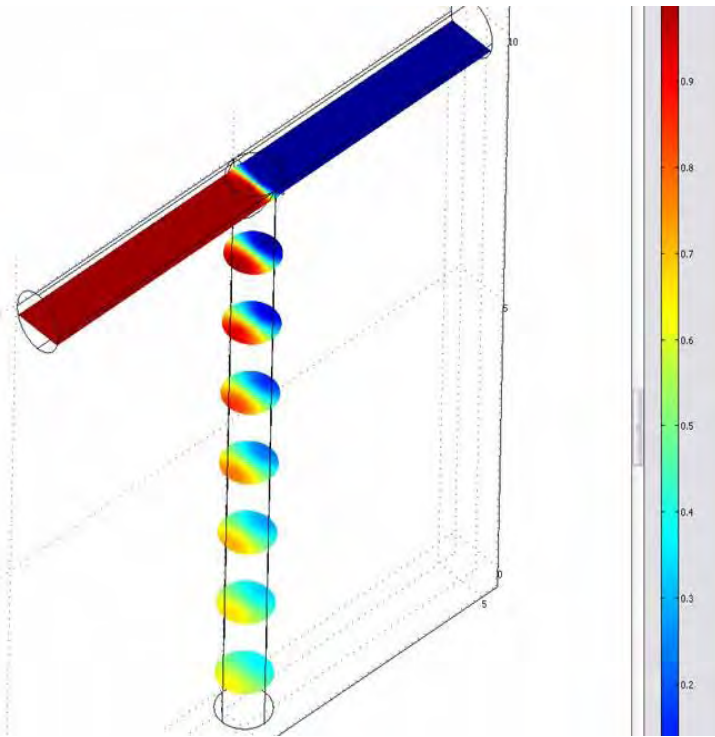

Why should the curves superimpose?

This is expected because the flow is basically straight down the device, except for the short entrance region, with diffusion sideways, and there is no convection sideways. Thus, diffusion controls the mixing, and the time in the device determines how far the material can diffuse. The parameter

$$\frac{z'}{Pe} = \frac{z}{x_s} \frac{D}{u_s x_s} = \frac{z / u_s}{x_s^2 / D} = \frac{t_{flow}}{t_{diffusion}}$$

is a ratio of the characteristic time for flow in the axial direction to the time for diffusion in the transverse direction.

Alternatively, one can examine the convective diffusion equation when there is no transverse velocity and deduce that axial diffusion term can be neglected compared with the axial convection term since their ratio is proportional to $1/Pe$.

$$w(x, y) \frac{\partial c}{\partial z} = D \left[\frac{\partial^2 c}{\partial x^2} + \frac{\partial^2 c}{\partial y^2} + \frac{\partial^2 c}{\partial z^2} \right]$$

Approximate Solution

$$u_{avg} \frac{\partial c}{\partial z} = D \frac{\partial^2 c}{\partial x^2}, \quad \frac{\partial c}{\partial z''} = \frac{\partial^2 c}{\partial x'^2}, \quad z'' = \frac{zD}{u_{avg} h^2}, \quad x' = \frac{x}{h}$$

$$c(0, z'') = 0.5, \quad c(x', 0) = 0, \quad \partial c / \partial x'(1, z'') = 0$$

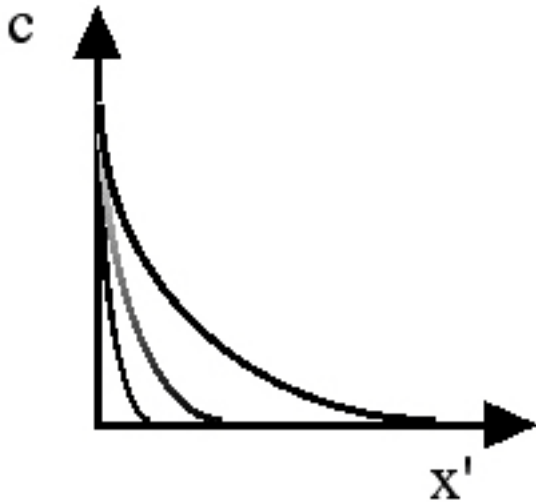

$$c = \begin{cases} 0.5 * (1 - a\eta)^2, & \eta < 1/a \\ 0, & \eta \geq 1/a \end{cases}, \quad \eta = \frac{x'}{\sqrt{4z''}}$$

(an approximation to the erfc function for an infinite domain)

Will find the best a using the Galerkin method.

Galerkin method (one of the Method of Weighted Residuals)

With the concentration dependent on the new variable η , the differential equation is:

$$\frac{\partial c}{\partial z''} = \frac{\partial^2 c}{\partial x'^2} \quad \eta = \frac{x'}{\sqrt{4z''}}, \quad \frac{d^2 c}{d\eta^2} + 2\eta \frac{dc}{d\eta} = 0$$

Inserting the trial function into the differential equation gives the residual:

$$c = 0.5 * (1 - a\eta)^2, \quad \eta < 1/a, \quad \text{Residual} = \frac{d^2 c}{d\eta^2} + 2\eta \frac{dc}{d\eta} = a^2 + 2\eta a(a\eta - 1)$$

The weighting function is:

$$\delta c = \frac{\partial c}{\partial a} = (1 - a\eta)(-\eta)$$

and the Galerkin method gives:

$$\int_0^{1/a} \delta c \text{ Residual } d\eta = 0, \quad a^2 = \frac{2}{5}$$

Solution until $\eta=1/a$ is at $x' = 1$

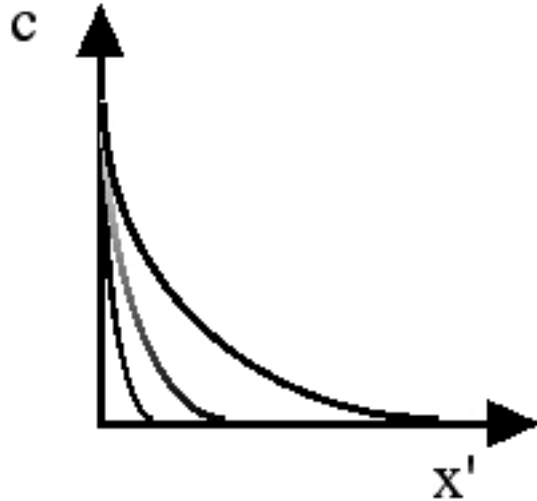

$$c = 0.5 * (1 - a\eta)^2, \eta < 1/a,$$

$$\eta = \frac{x'}{\sqrt{4z''}}, \quad a^2 = \frac{2}{5}$$

Valid until $\eta=1/a$ at $x' = 1$, or

$$z'' = \frac{1}{10}$$

$$\sigma^2 = 0.25 \left(1 - 1.476\sqrt{z''} \right), \quad z'' \leq 0.1$$

At $z'' = 0$. the variance is 0.133.

Approximate Solution for Longer Time

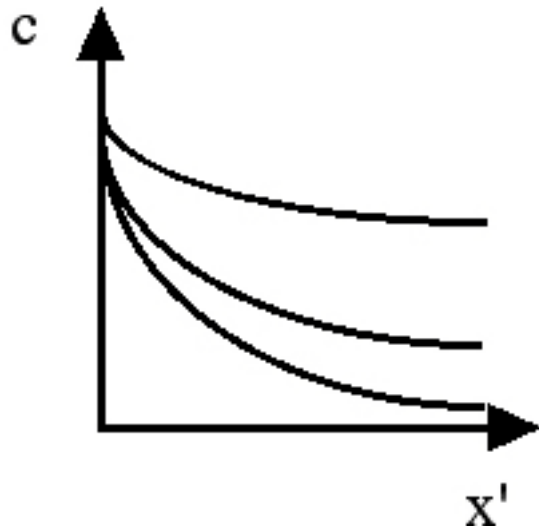

$$c = 0.5 + d(z'')(x'^2 - 2x')$$

is 0.5 at left, has zero slope at right, matches previous solution at $z''=0.1$ with $d(0.1)=0.5$.

$$\delta c = \frac{\partial c}{\partial d} = (x'^2 - 2x')$$

Galerkin method gives: $d(z'') = 0.642 \exp(-2.5z'')$

$$\sigma^2 = 0.220 \exp(-5z''), z'' > 0.1$$

Variance for T-sensor - Approximation Solution

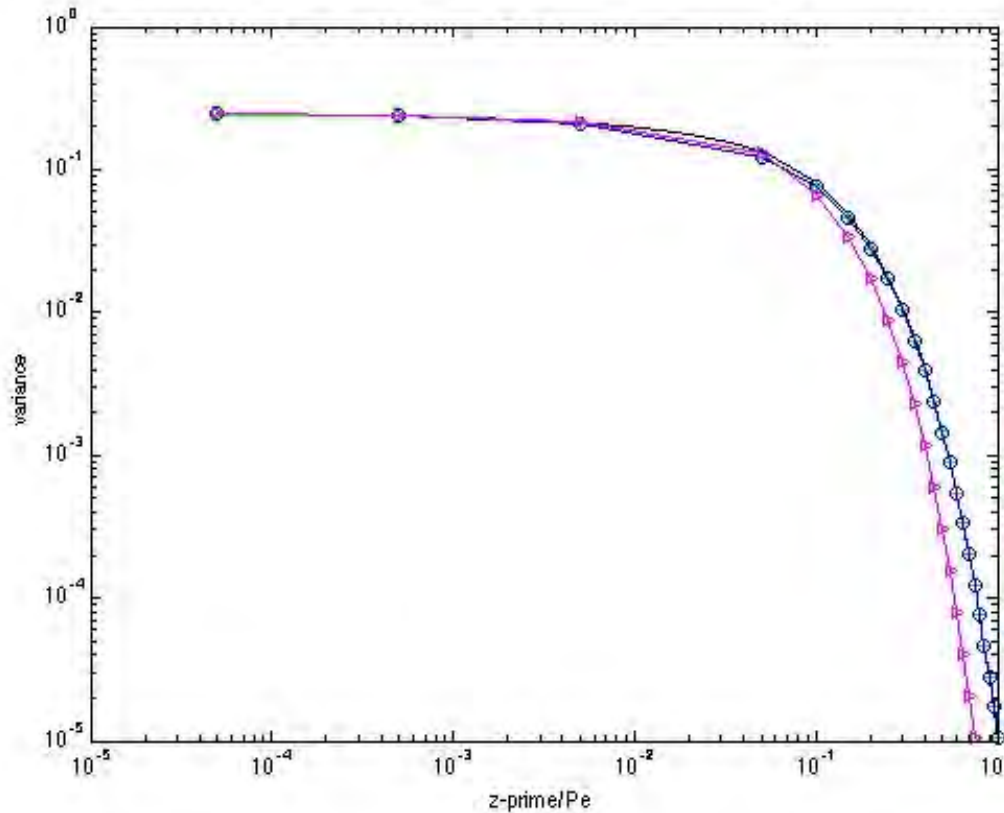

o– finite difference results and approximate solution, flat velocity profile;

triangle – finite difference results with quadratic velocity profile

Mixers to Characterize

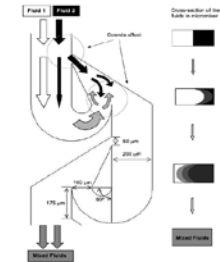
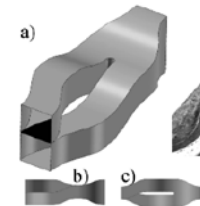
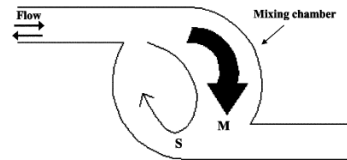
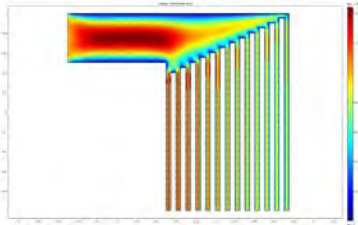
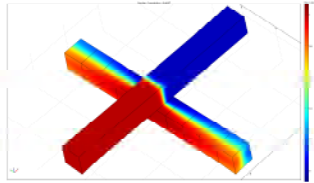
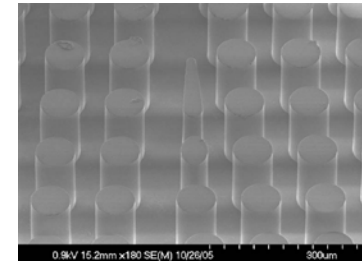
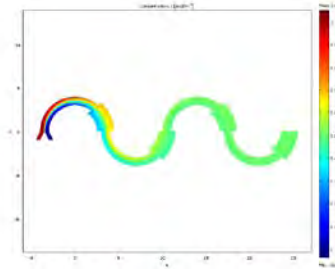
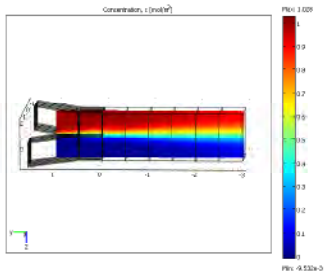

Questions to ask

- A. Do the variances collapse onto one curve if properly presented?
- B. Do your results follow the same curve of variance vs. as for a T-sensor?
- C. How different are the mixing cup and optical variances? Is this difference important?
- D. How do 2D and 3D results compare?
- E. What would you need to do in your device to reach a variance of 0.01? 0.001?
- F. What is the effect of Reynolds number? (This is pertinent only to a few of the geometries.)

T-sensor-like Devices

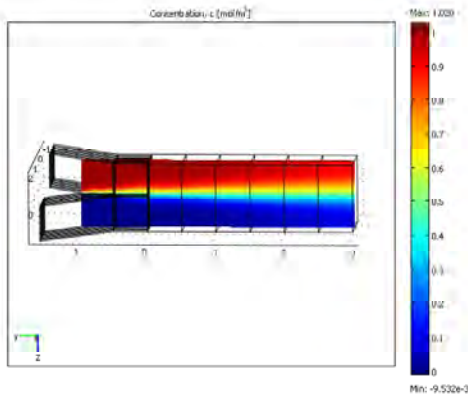

Sandwich, Hinsmann, *Lab Chip*, 1 16 (2001)

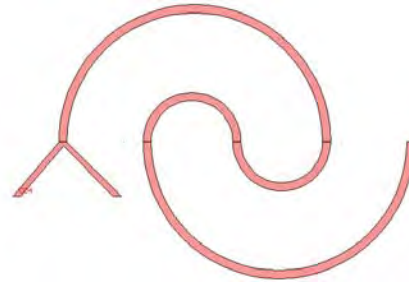

Planar spiral, Sudarson, *Lab Chip*, 6 74 (2006)

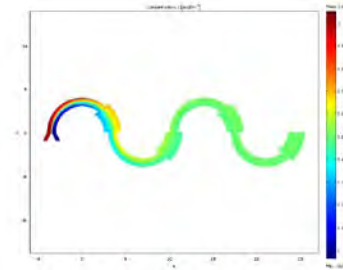

Rectangular expansion, Sudarson, *Lab Chip*, 6 74 (2006)

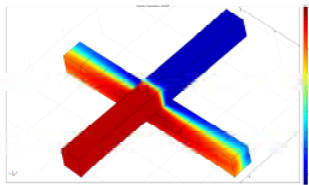

Crossed channels

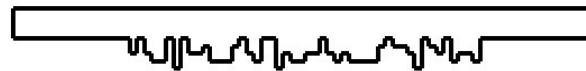

Rough channel, Kiplik, *Phys. Fluids A*, 6 1333 (1993)

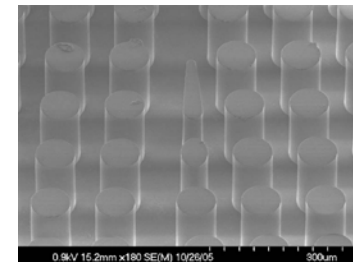

Micropillars, www.edge-embossing.com

"Mixing Efficiency in Rough Channels"

by Francis Ninh

Kiplik, Phys. Fluids A, **6** 1333 (1993)



Variance Across 3D Channel at Varying Peclet Numbers

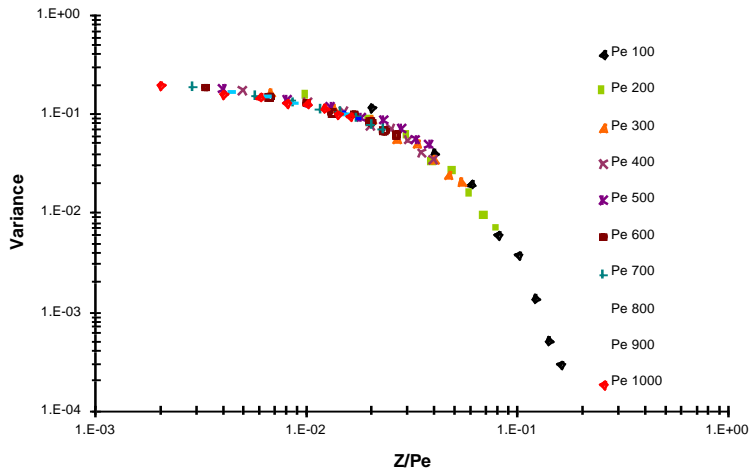

Comparison of Mixing Efficiency of Rough Channel to T-Sensor and Flat Plates

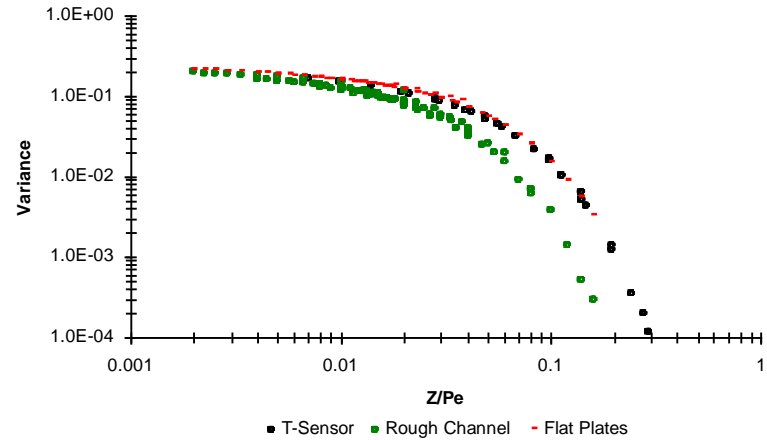

“Evaluation of Concentration Variance as a Function of z'/Pe ”

by Jordan Flynn

Holden, Sensors Actuators B, **92** 199 (2003)

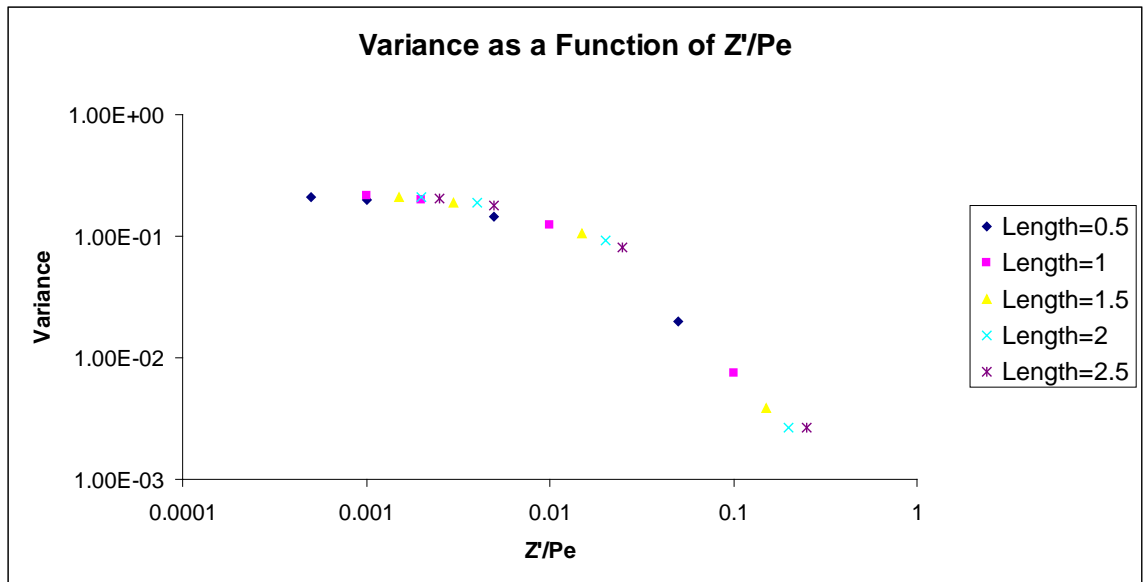
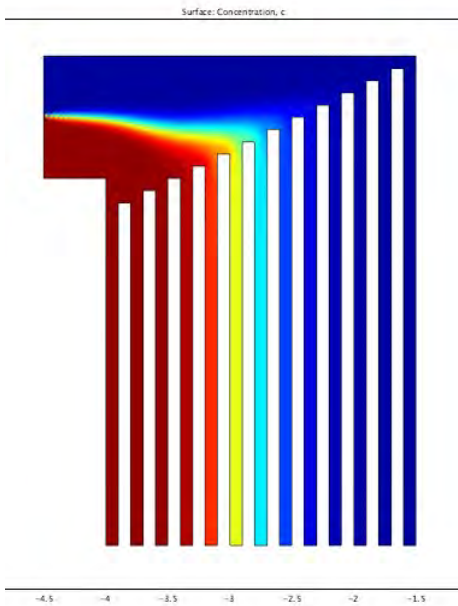

Pe from 10 to 1,000

"Mixing in Flow Devices: Spiral Channels"

by Ha Dinh

Sudarson, Lab Chip, 6 74 (2006)

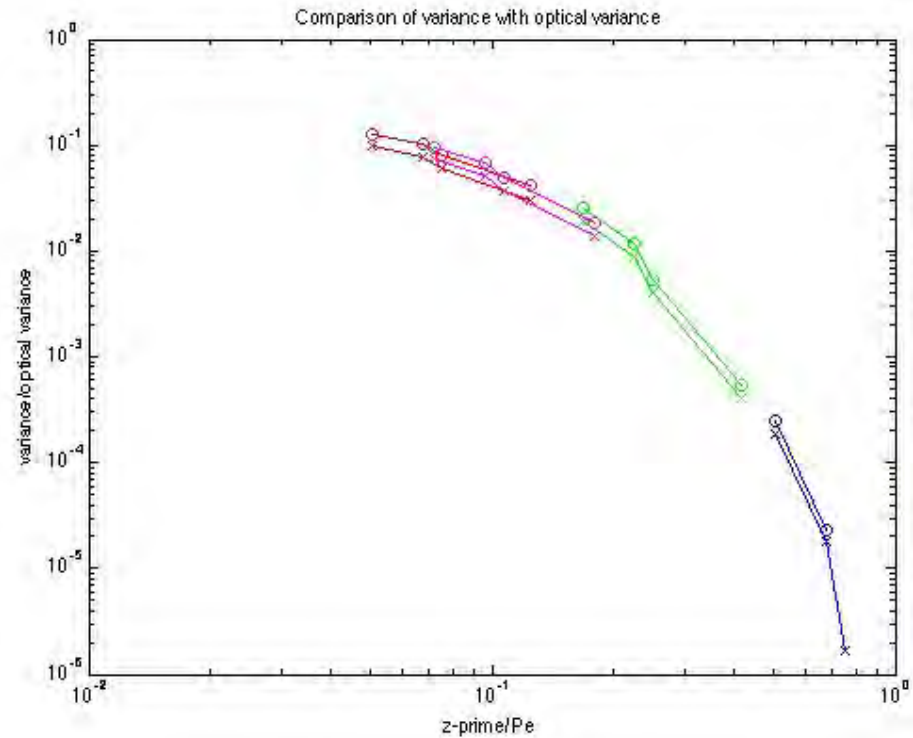
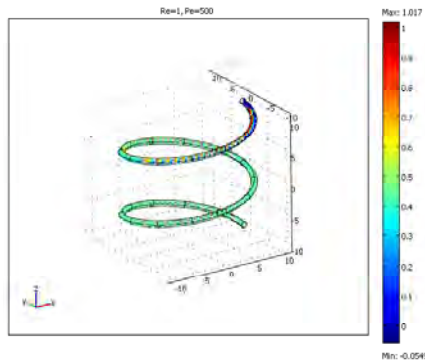
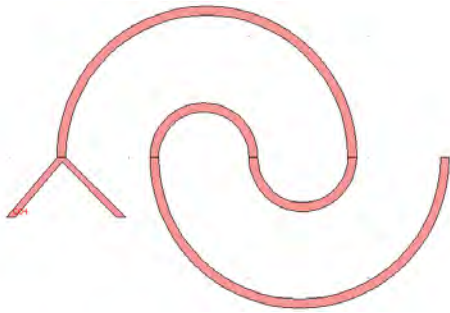

Variations for T-sensor-like Devices

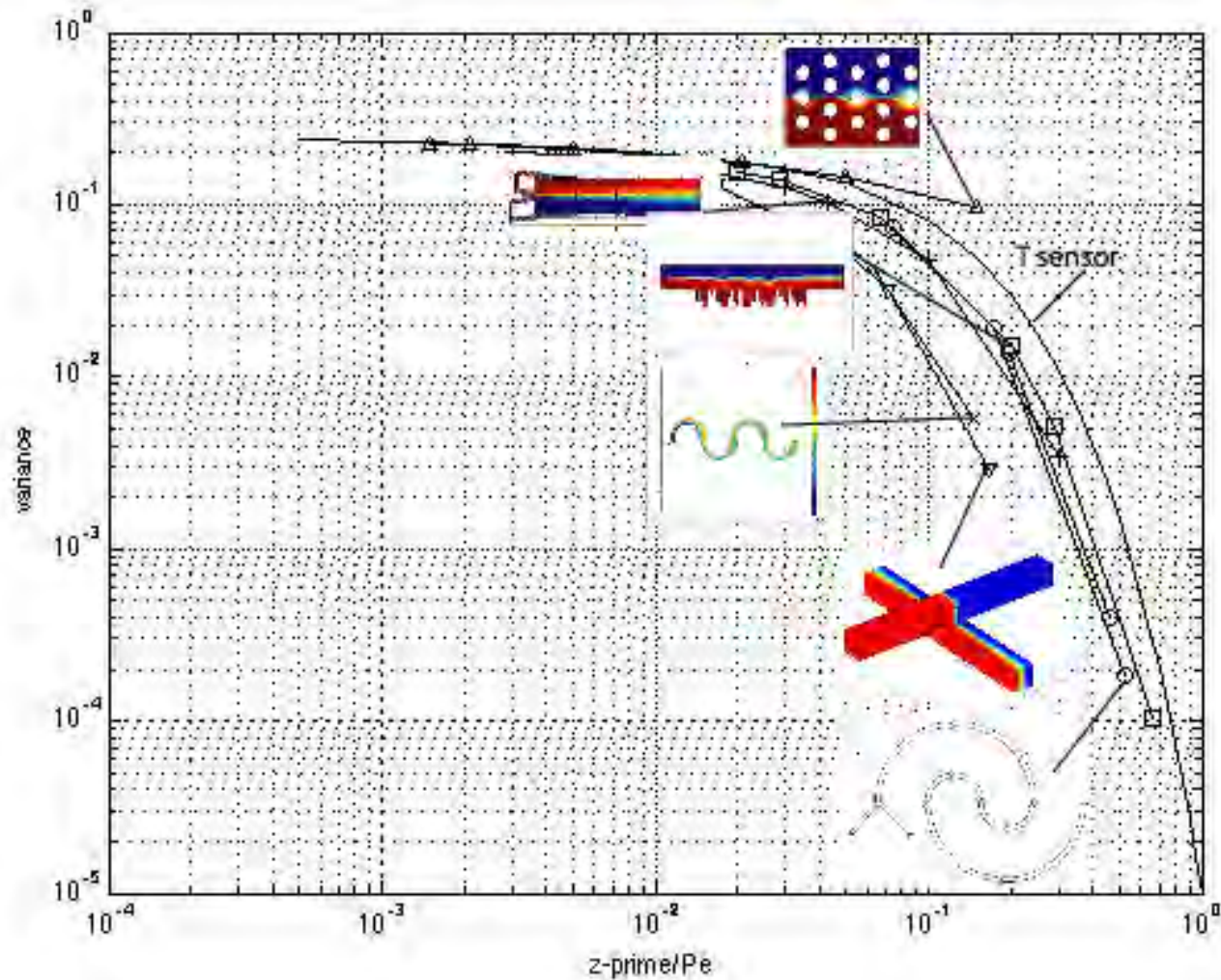

Inertial Devices

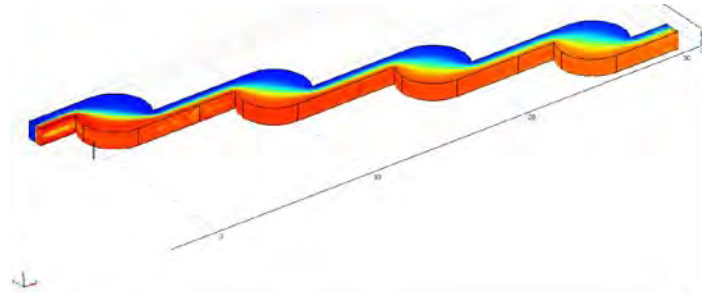
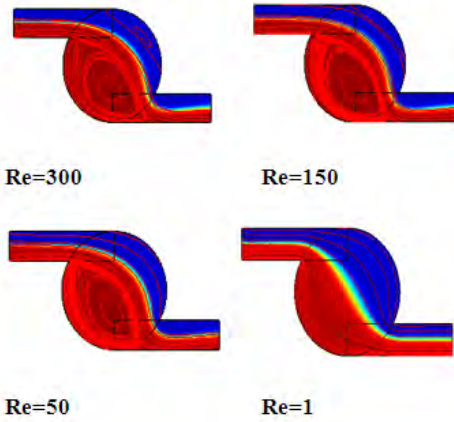

Mixing chamber, Chung, *Lab Chip* 4 70 (2004)

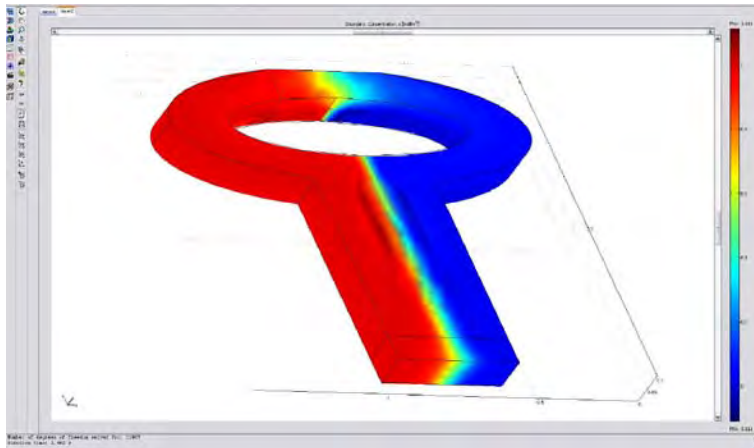

Tear drop, micronit.com

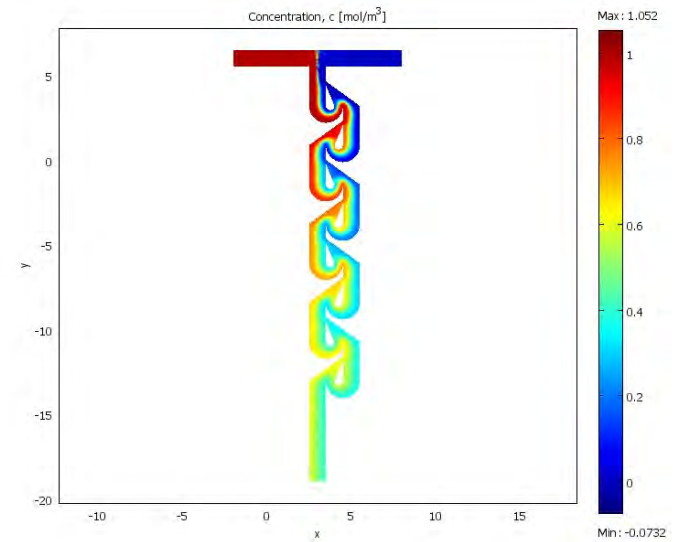

Tesla, Hong, *Lab Chip* 4 109 (2004)

“Self Circulating Mixer Chamber”

by Cindy Yuen

Chung, Lab Chip, 4 70 (2004).

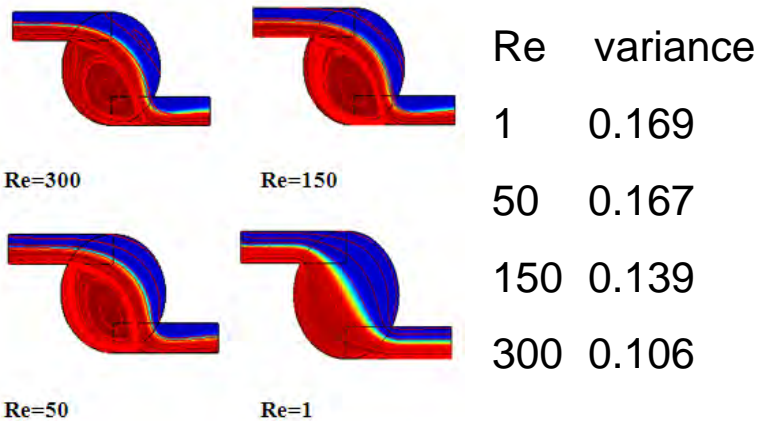
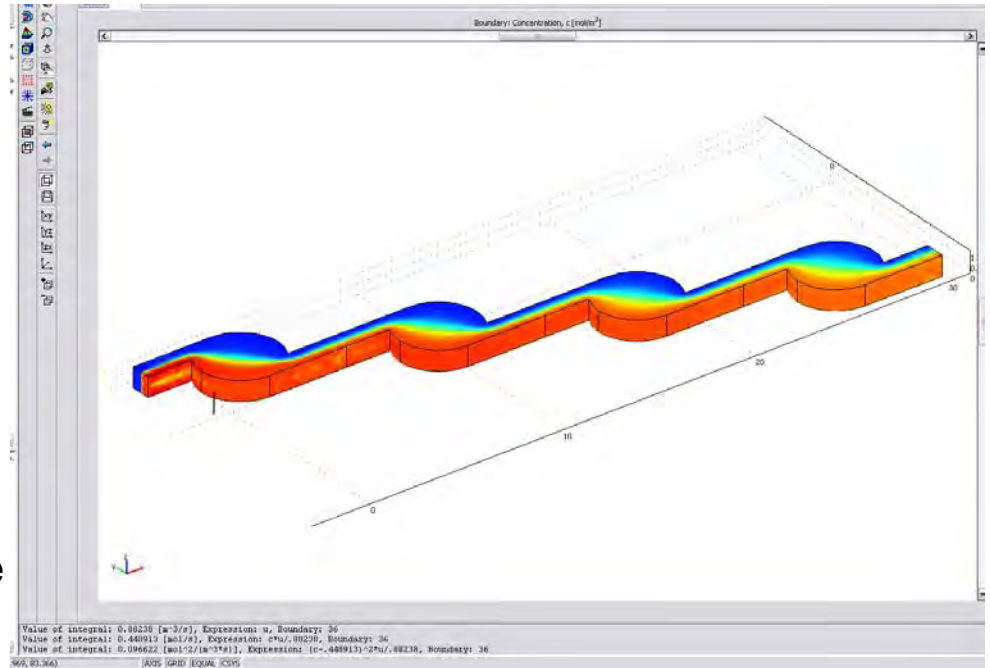
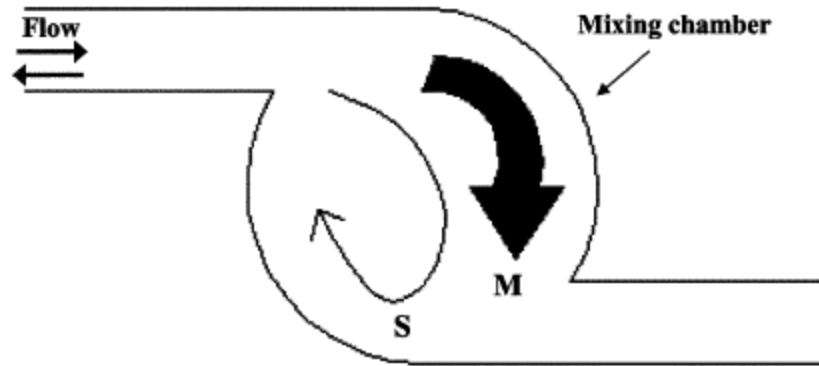

"Microfluidic Research: Mixing Effectiveness of Modified Tesla Structures"

by Curtis Jenssen

Hong, Lab Chip, 4 109 (2004)

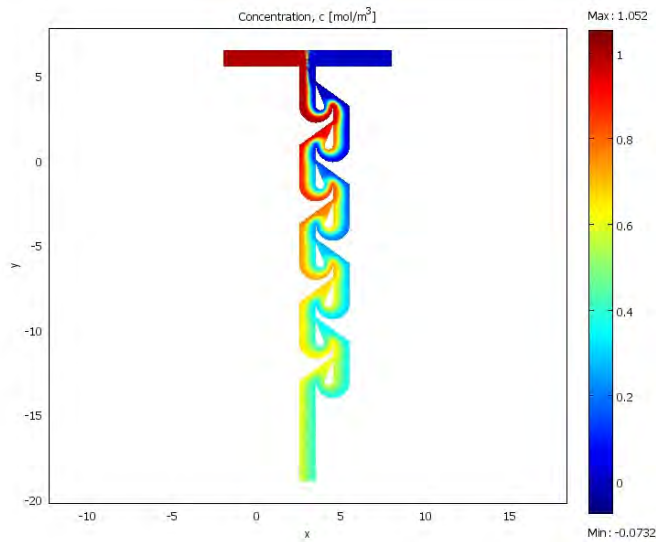
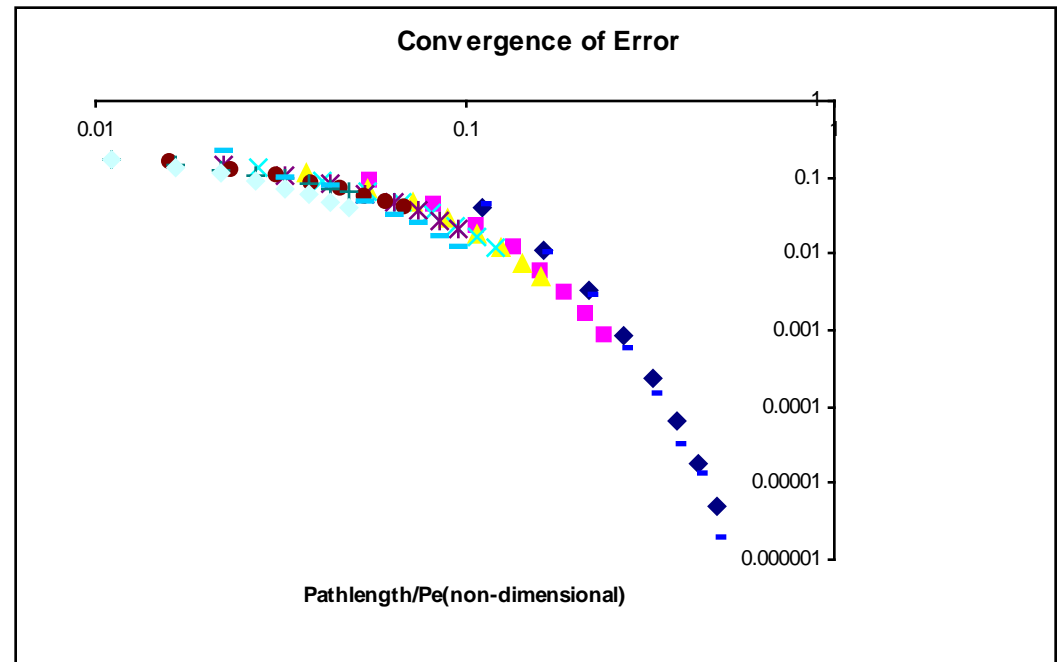
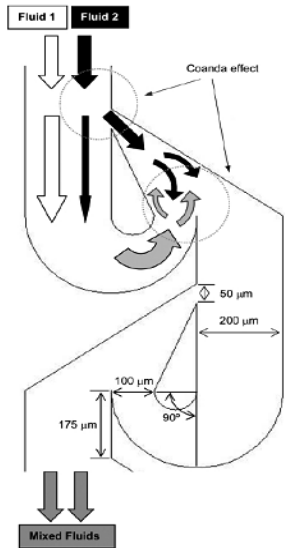

Variations of Inertial Devices

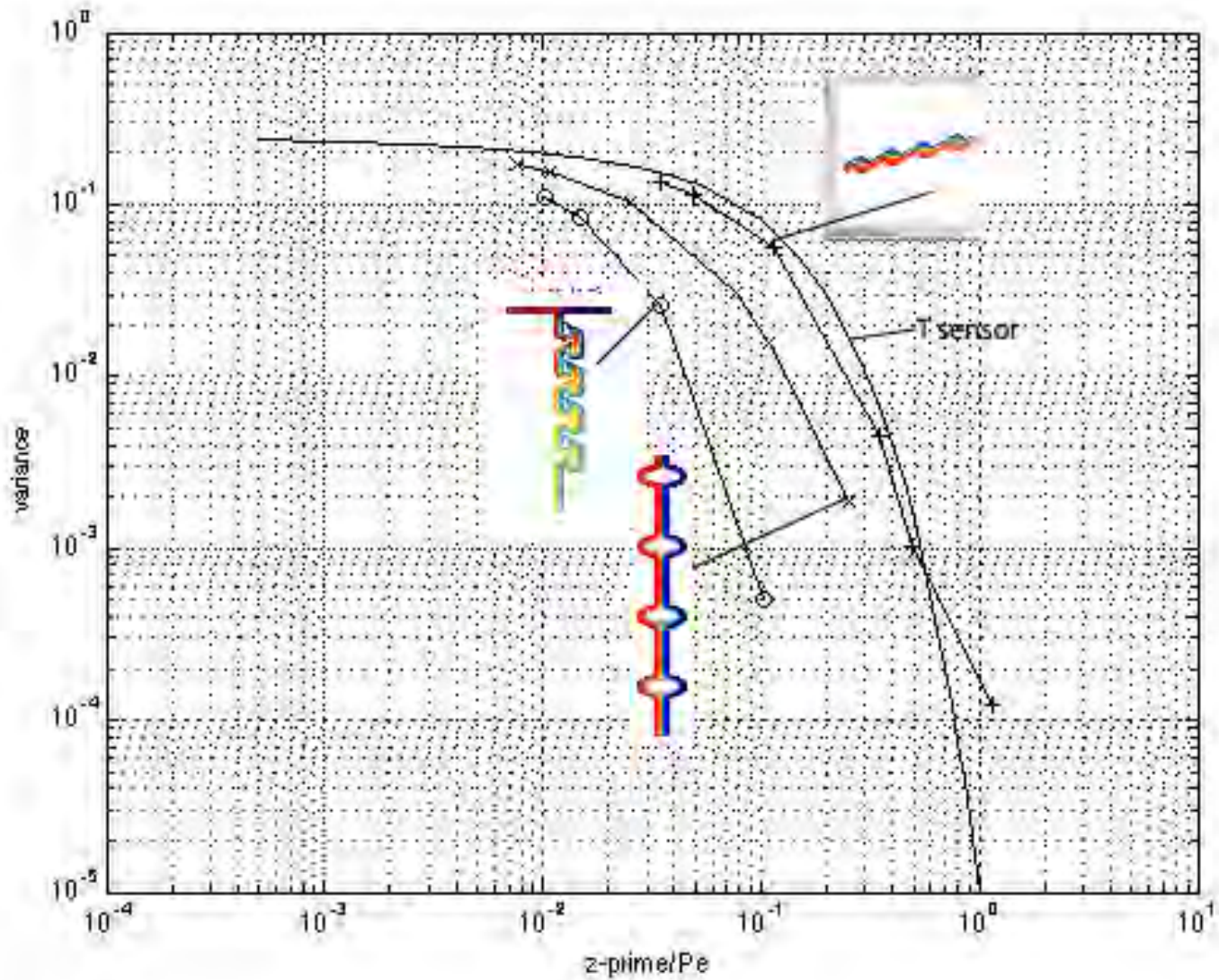

Serpentine Mixer

Lab on a Chip 4 342-350 (2004)

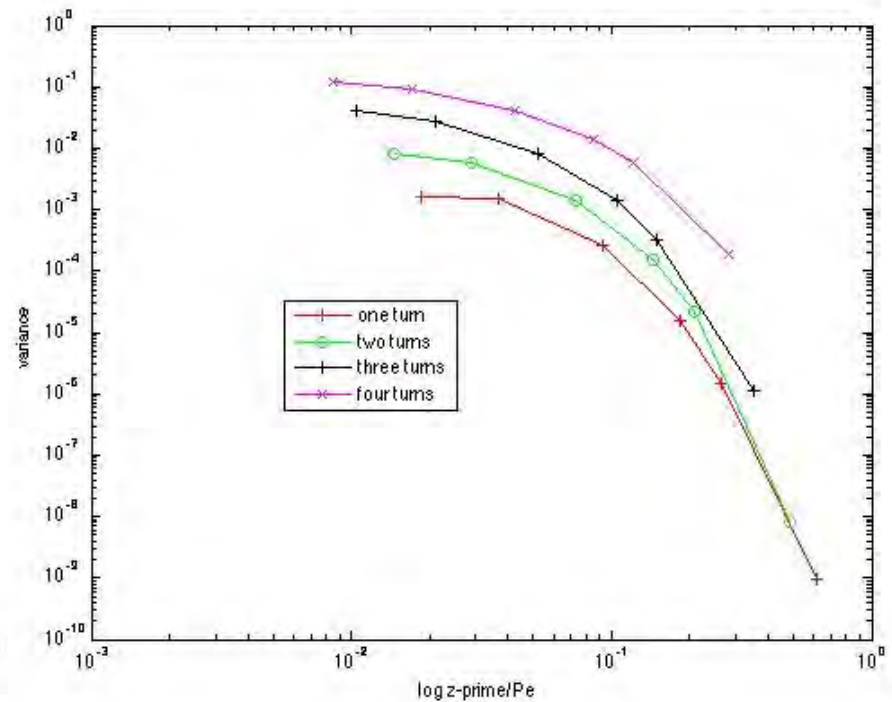
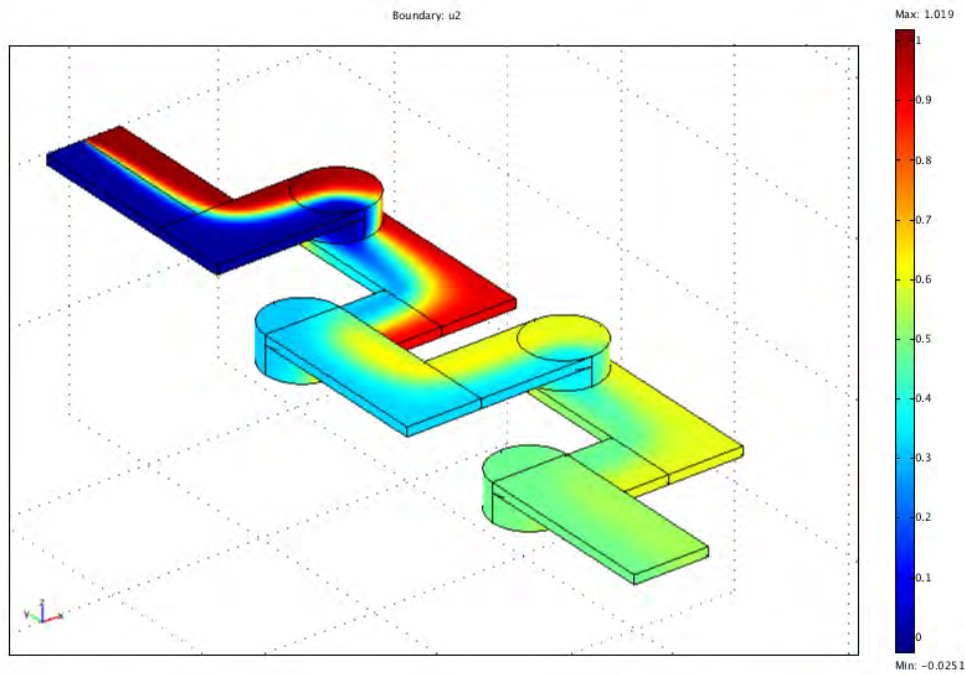

Conclusions

- The variance for each geometry, for $Re = 1$, fell on one curve as a function of Re . The curve was similar in all cases, but shifted a bit for each device.
- The optical variances differed from the mixing cup variance somewhat, but not significantly on a logarithmic scale.
- Oftentimes the 2D simulations give a good representation of the 3D simulations; the cases when this doesn't hold is when the flow is particularly 3D in nature to induce mixing.
- If the device is similar to a T-sensor, increasing the Reynolds number makes little difference. The mixing is improved with increasing Reynolds number for geometries that induce laminar vortices based on inertial effects.

information for laminar flow. The students were Dreyfus Undergraduate Research Scholars, under the Senior Mentor Program awarded to Professor Finlayson by the [Camille & Henry Dreyfus Foundation, Inc.](#)

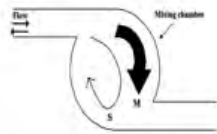

Chung, *Lab Chip*, 4 70 (2004)

[Cindy Yuen](#)

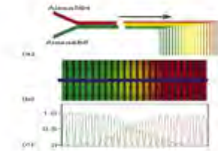

Holden, *Sensors Actuators B*, 92 199 (2003)

[Jordan Flynn](#)

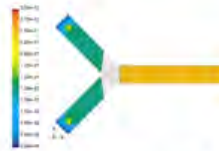

Hinsmann, *Lab Chip*, 1 16 (2001)

[Vann Brasher](#)



Schonfeld, *Lab Chip*, 4 65 (2004)

[Lisa Dahl](#)

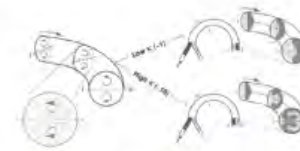

Sudarson, *Lab Chip*, 6 74 (2006)

[Ha Dinh](#) (round); [Ho Hack Song](#) (square)

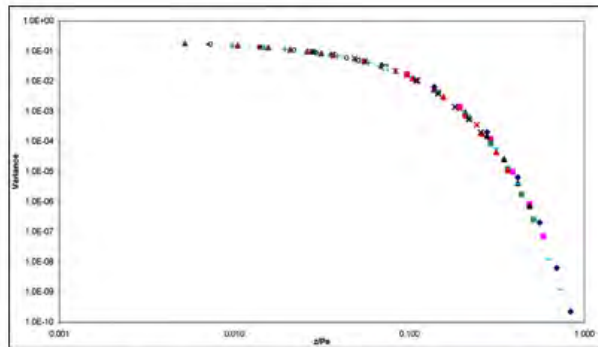

Variance vs. z/Pe ; T-junction, 2D results Fig. 8.17 (Ch. in *Micro-Instrumentation*, (M. Koch, K.Vanden Bussche, R. Chrisman (ed.), Wiley, 2007).), 3D results, [Daniel Kress, Sp. 2007](#)

Each student used [Comsol Multiphysics](#) to characterize the diffusion and convection in a different microfluidic device, examining the following questions:

1. Is there a universal curve governing the results?
2. Can 2D simulations give a good representation of 3D situations?
3. What does it take to achieve good mixing?

Click on the Student's Name to obtain more information.



Front: Andy, Andrew, Cindy, Ha, Vann, Francis; Back: Bruce, Aaron, Adam, Ho Hack, Lisa, Curtis, Jordan



Kiplik, *Phys. Fluids A*, 6 1333 (1993)

[Francis Ninh](#)

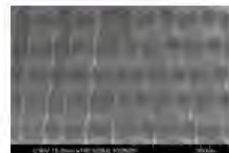

Andy Kamholtz

[Andy Aditya](#)

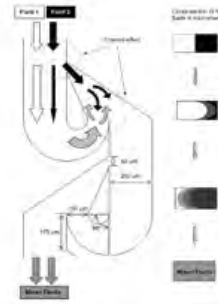

Hong, *Lab Chip*, 4 109 (2004)

[Curtis Janssen](#)



[Adam Field](#)

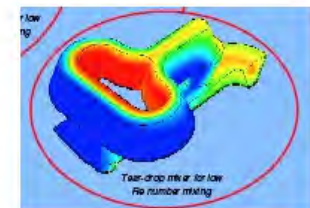

micronit.com

[Andrew Nordmeier](#)

[Information about process intensification](#) - [Information about medical usage of microfluidics](#) - [Respond to instructor: e-mail.](#)

Other web sites with more information include: [Ch.E. 499, Autumn, 2007](#), [Ch.E. 499, Spring, 2007](#), [Ch.E. 499, Winter, 2007](#)

[Ch.E. 499, Autumn, 2006](#) - [Ch.E. 499, Spring, 2006](#) - [Ch.E. 499, previous quarters](#)

Spring Chem. Engr. 499 Undergraduate Research



<http://courses.washington.edu/micr>

oflo/

Thanks to Dreyfus Foundation for a Senior Mentor Grant - which paid part of the tuition of students