

Tribological Behavior of Rubber Seals on Glass Barrels in Prefilled Syringes

Trevor Langley¹

Ernesto Gutierrez-Miravete²

¹ Graduate Student, Rensselaer, Troy

² Professor of Practice, Rensselaer Hartford

COMSOL 2018

Introduction and Objective

- Injection is one of the most commonly used health care procedures in the world since it is an effective technique used for delivering drugs by parenteral administration.
- Modern automated injection systems facilitate the application of precision operator-controlled injections.
- This presentation describes continuing modeling work performed at RPI to better understand the dynamics of the injection process with the objective of designing improved automated injection systems.
- The focus on this work is on the tribological behavior of sliding rubber seals on syringe glass barrels.

General Description of the Model

- The model is based on fundamental principles of solid and contact mechanics and was designed to investigate the tribological behavior of a rubber seal sliding inside a glass syringe barrel.
- The steady state model simulates the start of an injection process for a syringe consisting of a glass barrel and plunger and a rubber seal.
- The syringe is assumed filled with fluid and the model is used to estimate deformation and forces in the rubber seal as the plunger is pushed by a small amount.

Prefilled Syringe Components

ASSEMBLY INSTRUCTIONS FOR ROFERON-A PREFILLED SYRINGE

Syringe components:

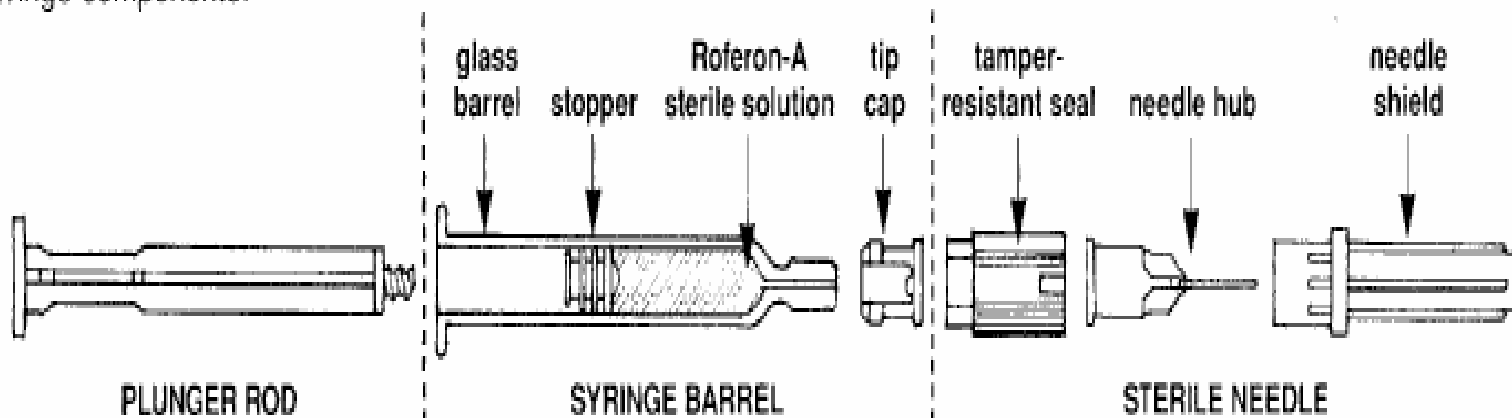

Plunger, Barrel and Seal in a Typical Syringe

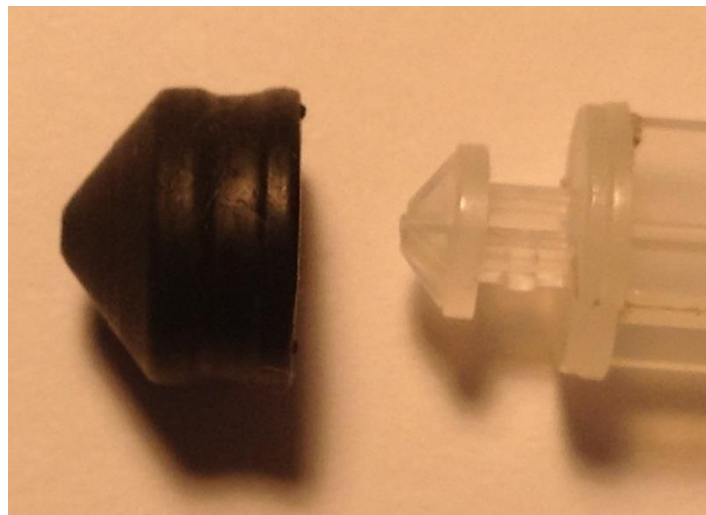

Geometry

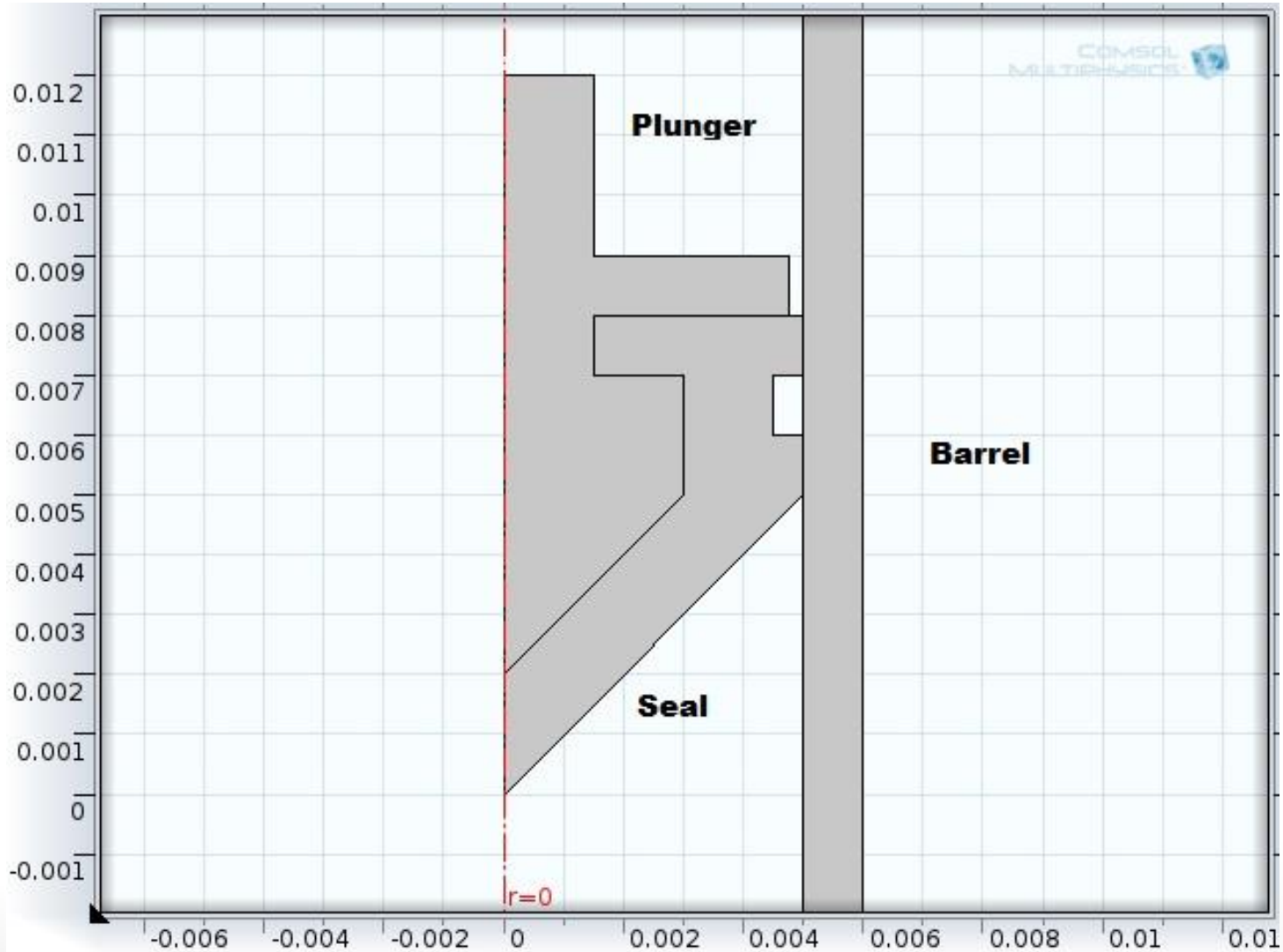

Key Assumptions

- Deformations are small so linear elastic behaviors for seal, barrel and plunger are assumed.
- There is mechanical contact and friction between seal and barrel.
- Axis-symmetric system.

Material Properties

Property	Glass	Rubber
E (GPa)	74	0.05
ν (-)	0.3	0.49
ρ (kg/m ³)	2200	945

Boundary Conditions

- On the outside surface of the barrel zero displacement assumed.
- On the lower surface of the plunger a small pressure due to the liquid in the syringe assumed.
- On the upper surface of the plunger a small downward displacement assumed.
- Along the seal-barrel interface a small initial gap is assumed.
- Static friction coefficient between rubber seal and glass barrel assumed constant .

Typical Results

Overall Total Displacement Field

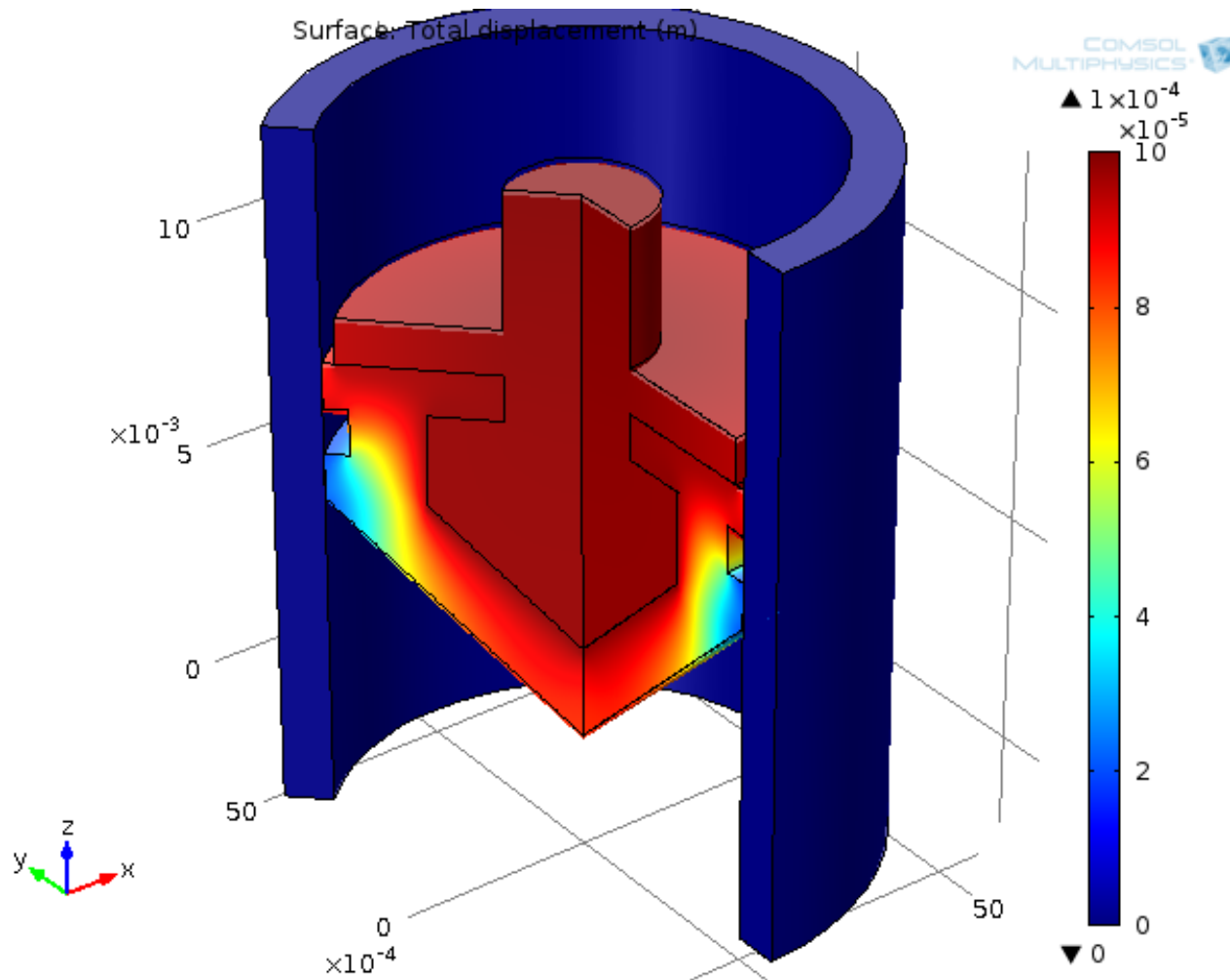

Typical Results

Seal Deformation and Displacement Field

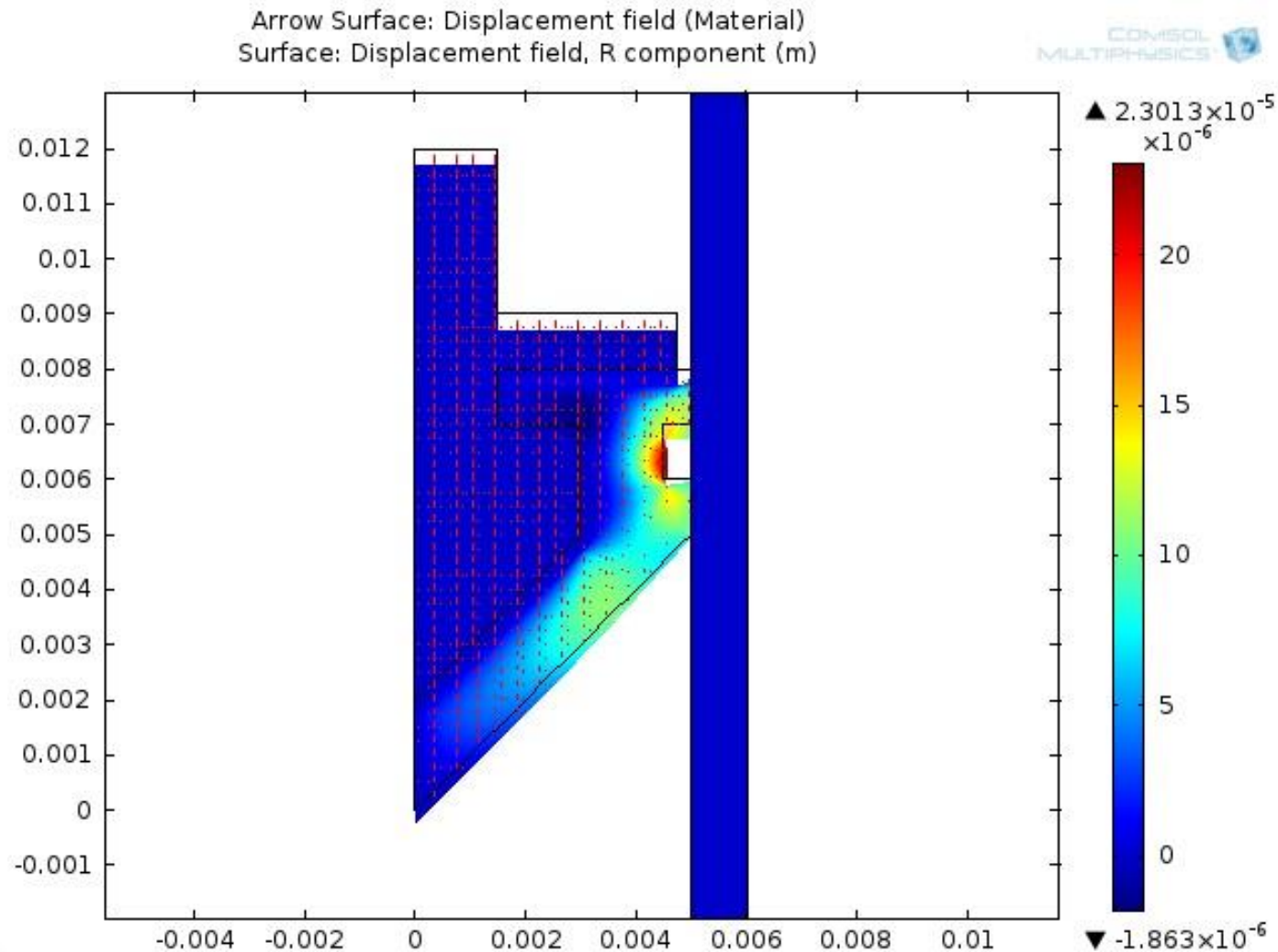

Typical Results

Seal Deformation and Displacement Field Detail

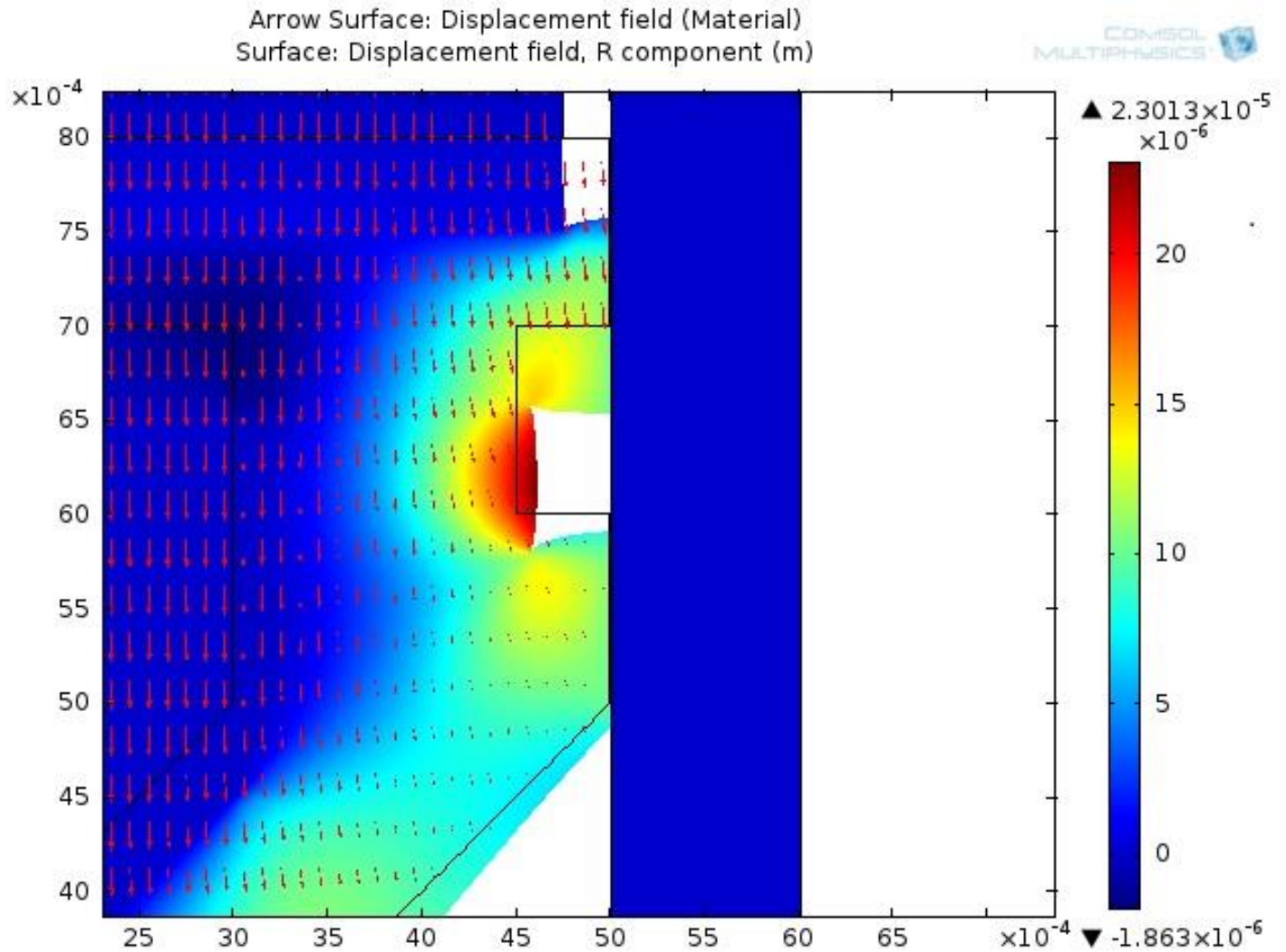

Typical Results

Seal-Barrel Computed Contact Pressure

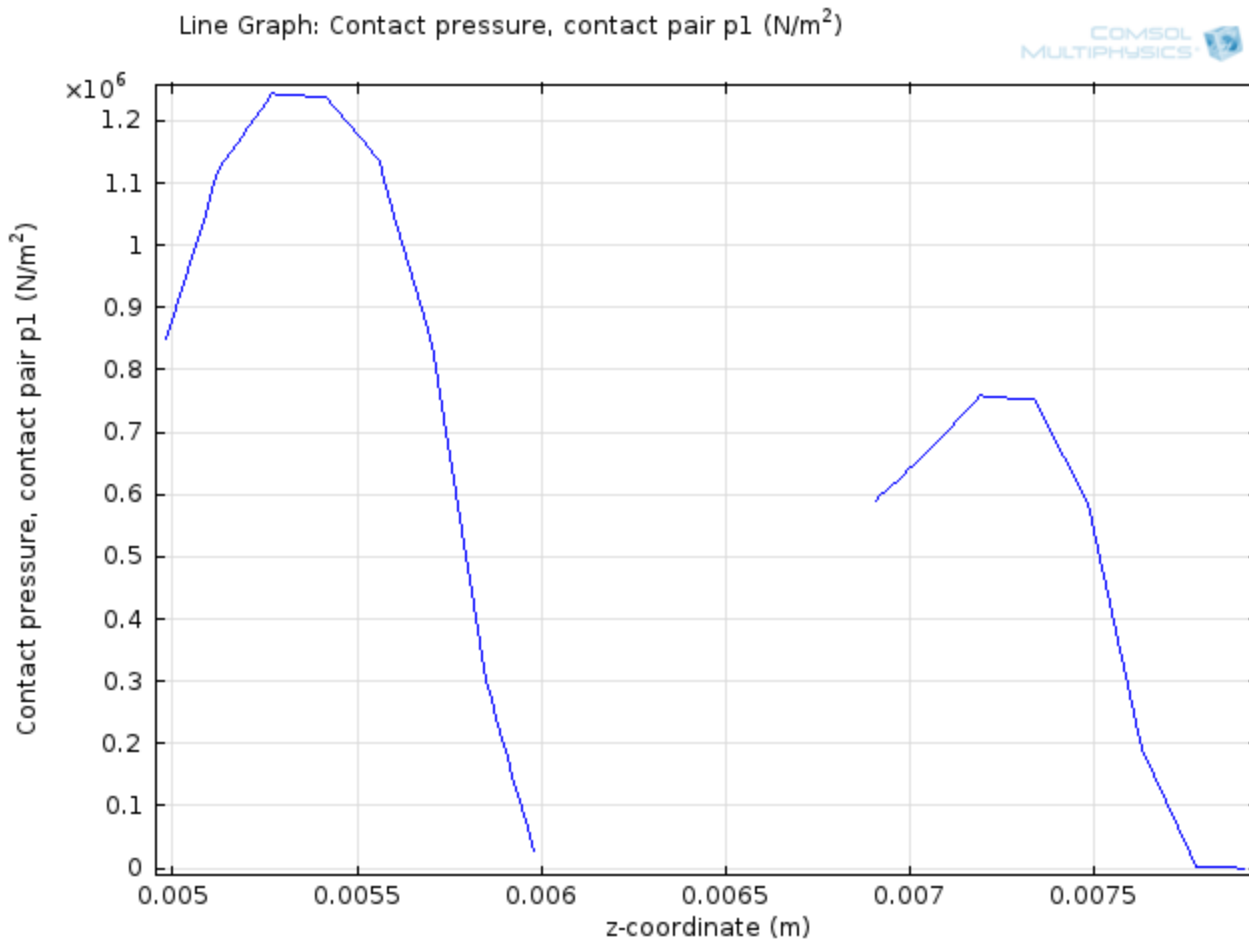

Typical Results

Seal-Barrel Computed Gap

Line Graph: Gap distance including offsets, contact pair p1 (m)

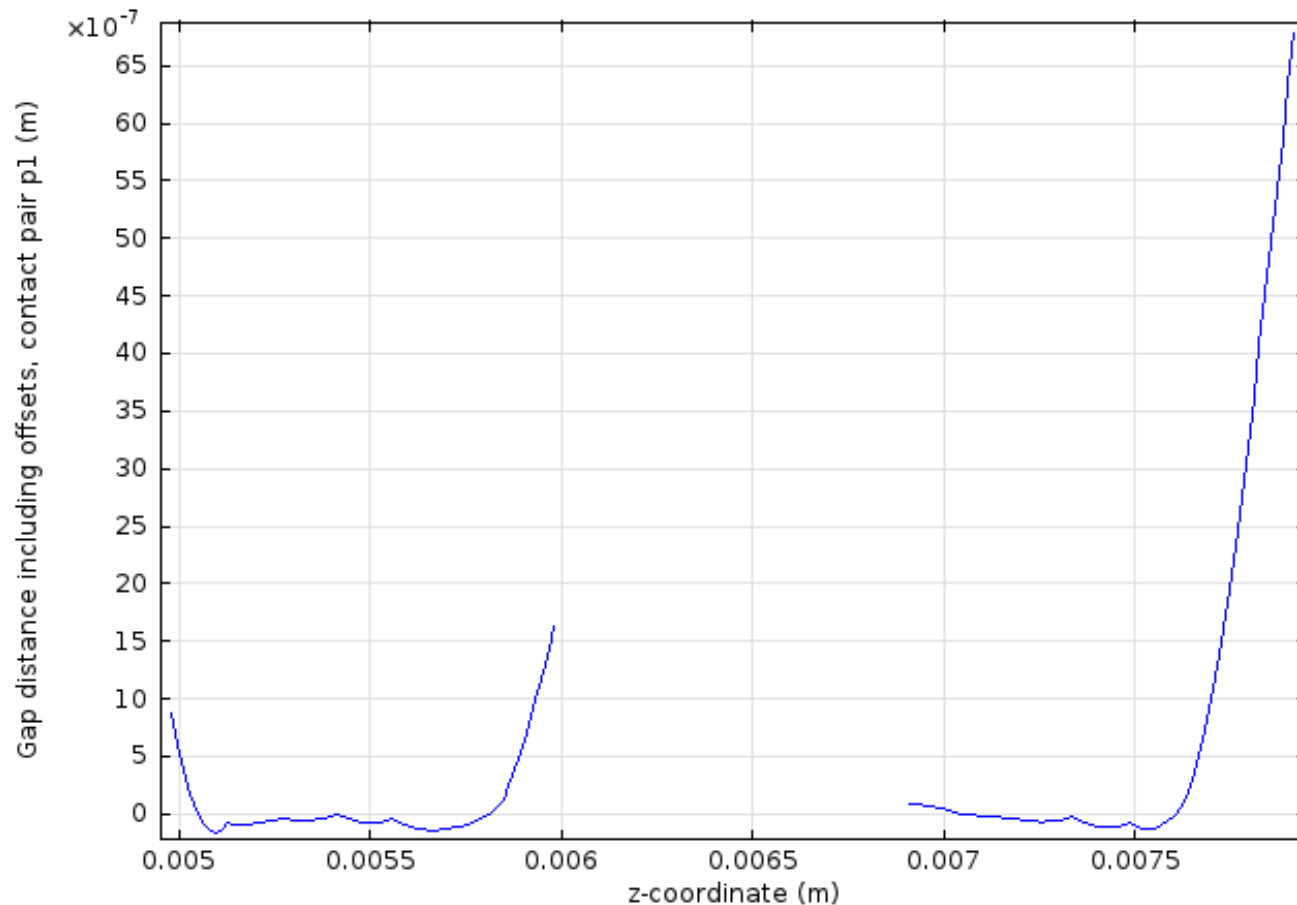

Summary

- Finite element modeling helps understanding the contact dynamics of plunger-seal-barrel systems in common syringes.
- Model results may be used to estimate required injection forces in automated injection system.
- Model results may be used to optimize seal designs.