

# A 3D Thermal Model for Prediction Temperature Field During Artificial Ground Freezing

Song Zhang<sup>1,2</sup>, Zurun Yue<sup>1</sup>, Tianliang Wang<sup>1</sup>

1. Shijiazhuang Tiedao University, Shijiazhuang, Hebei, China

2. Beijing China Coal Mine Engineering Co. Ltd. Beijing, China

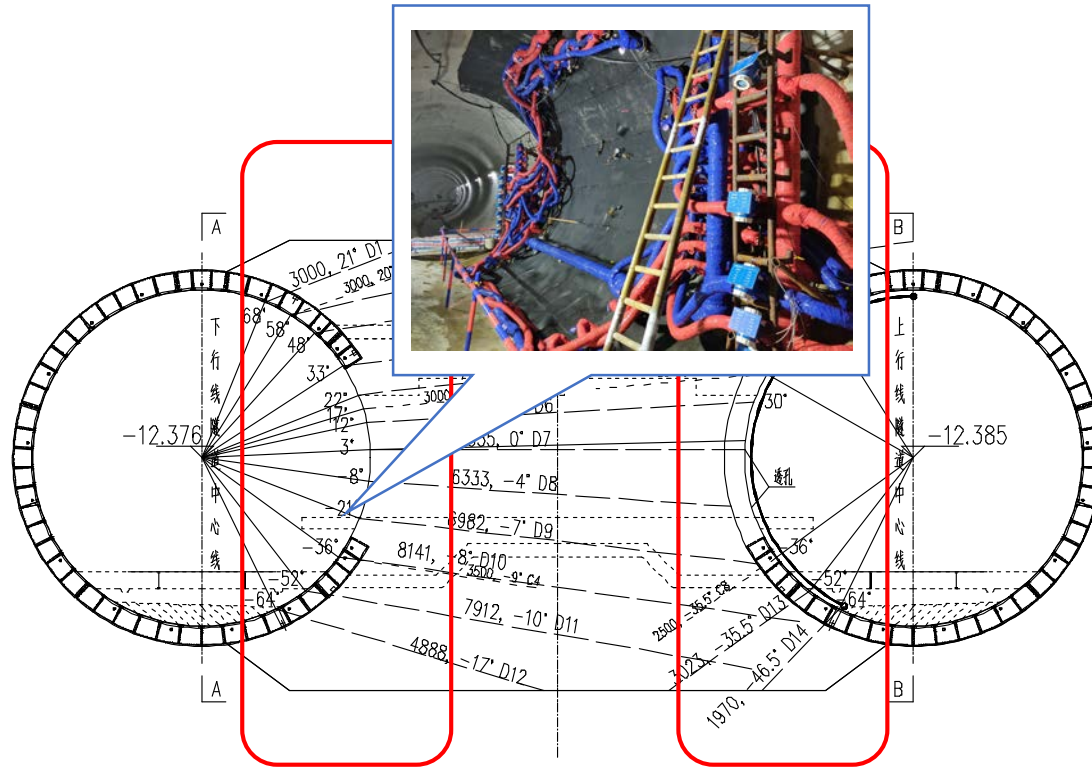

The AGF method has been applied widely in underground engineering. More than 90% cross-passage Tunnel in yangtze delta region was built by AGF.

The freezing wall close to segment is weaker than design in active freezing period. So it extend the freezing period 20d. And the cost of project increased more than ¥ 100,000.00.

# Finite Element Model

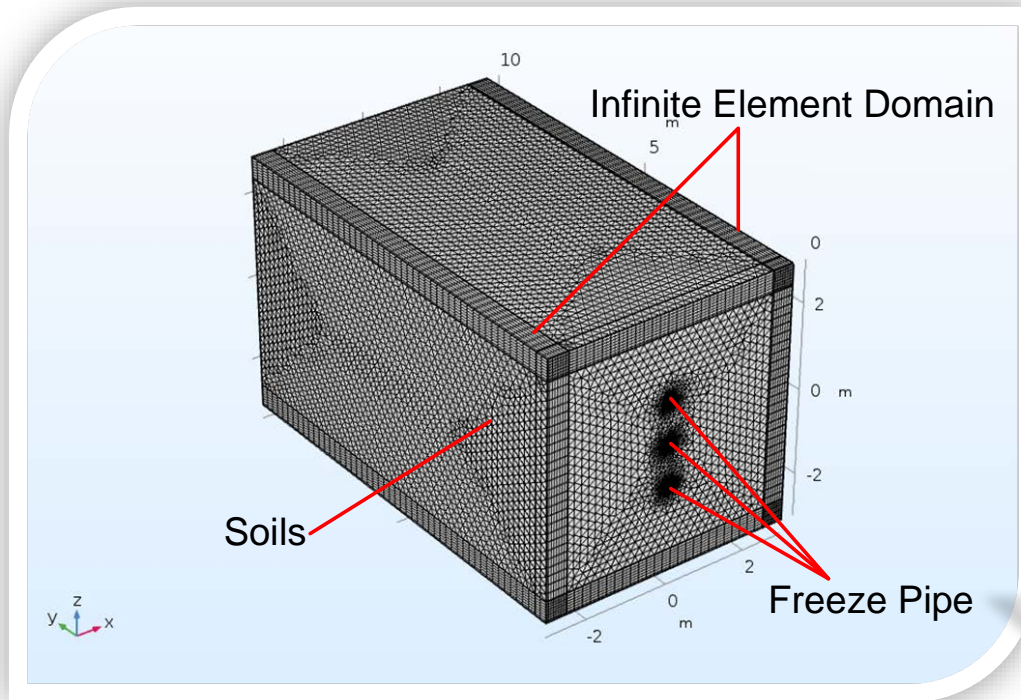

## Governing Equations

$$C_{eq} \cdot \frac{\partial T}{\partial t} - \nabla(k_{eq} \cdot \nabla T) + L_i \cdot \rho_w \cdot \Delta \omega_i = Q_G$$

$$Q_G = k' \cdot (T_a - T_s) \cdot A$$

Material	Thermal conductivity W/(m·K)	Specific heat J/(kg·K)	Density kg/m <sup>3</sup>
soil	1.4	1300	1364
Frozen soil	2.1	1022	1840
Concrete	1.8	880	2300
Thermal insulation material	0.03	540	560

In order to obtain the temperature field in different conditions, it make a 3D Thermal Model to study

# Finite Element Model

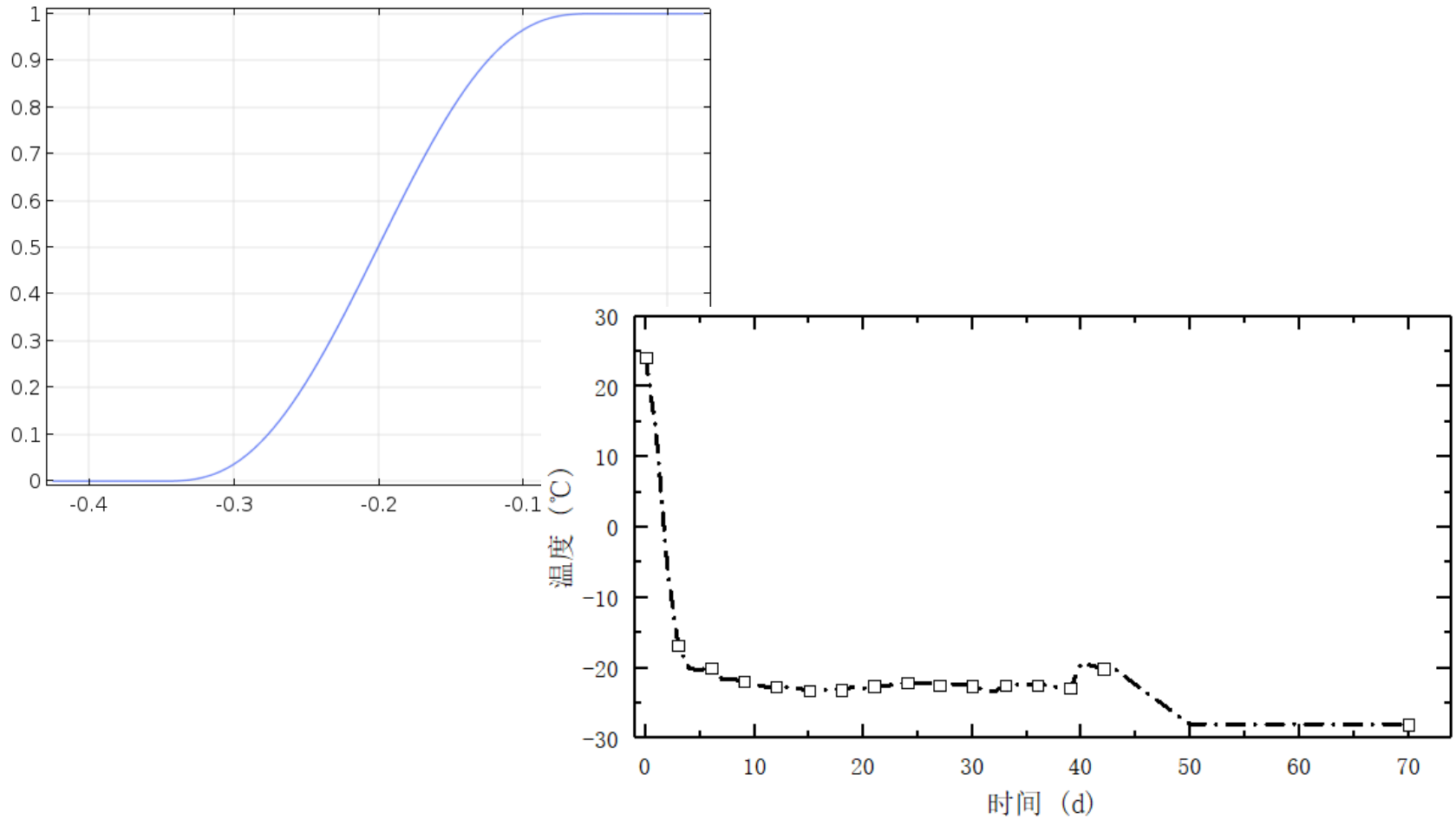

**The step function for materials and the temperature for brine**

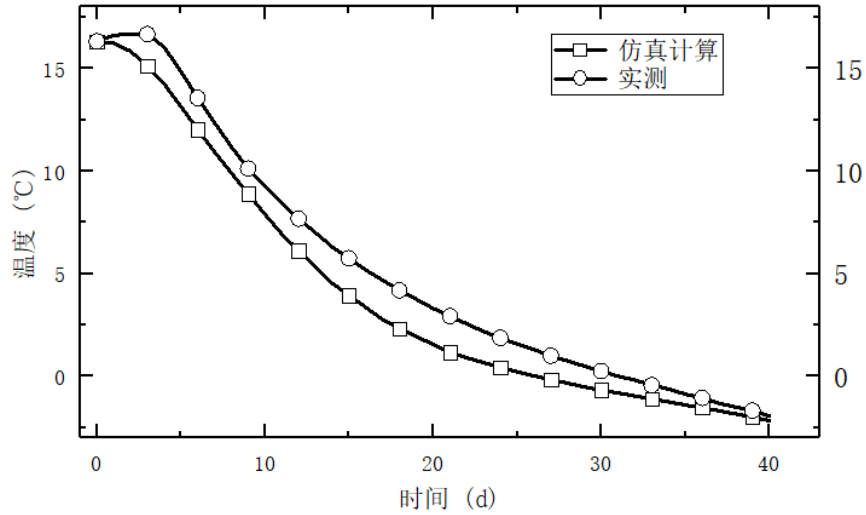

Compare with in-situ data  
and simulation

Temperature field close to  
segment

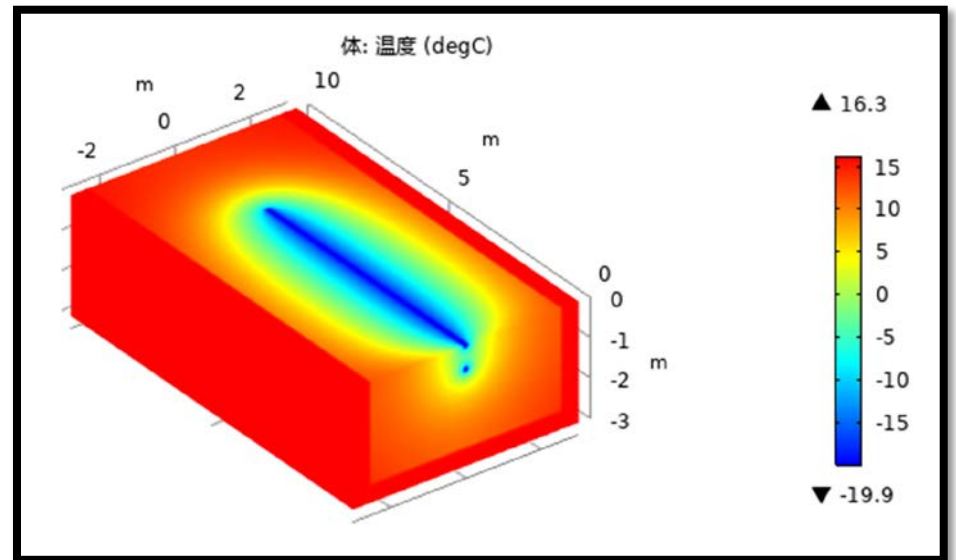
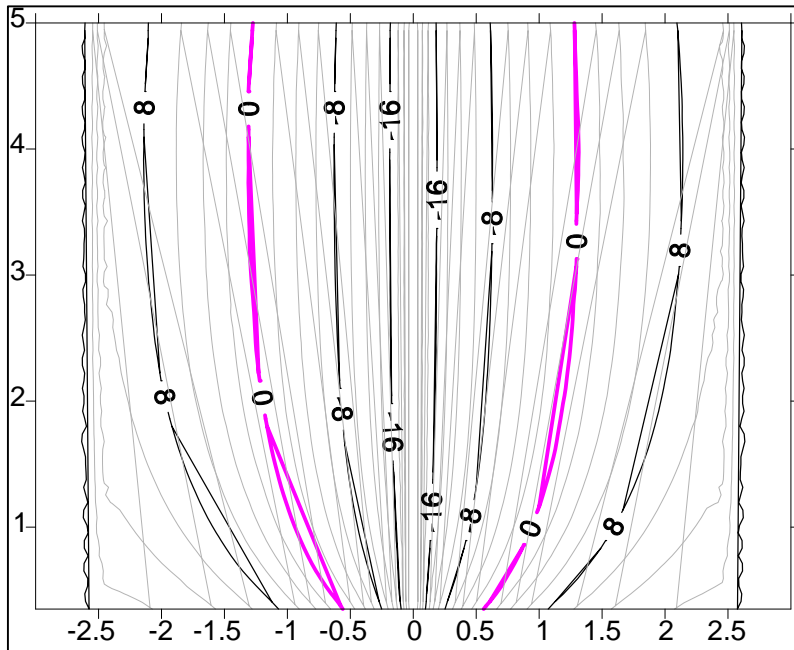
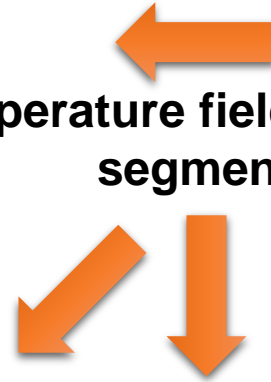

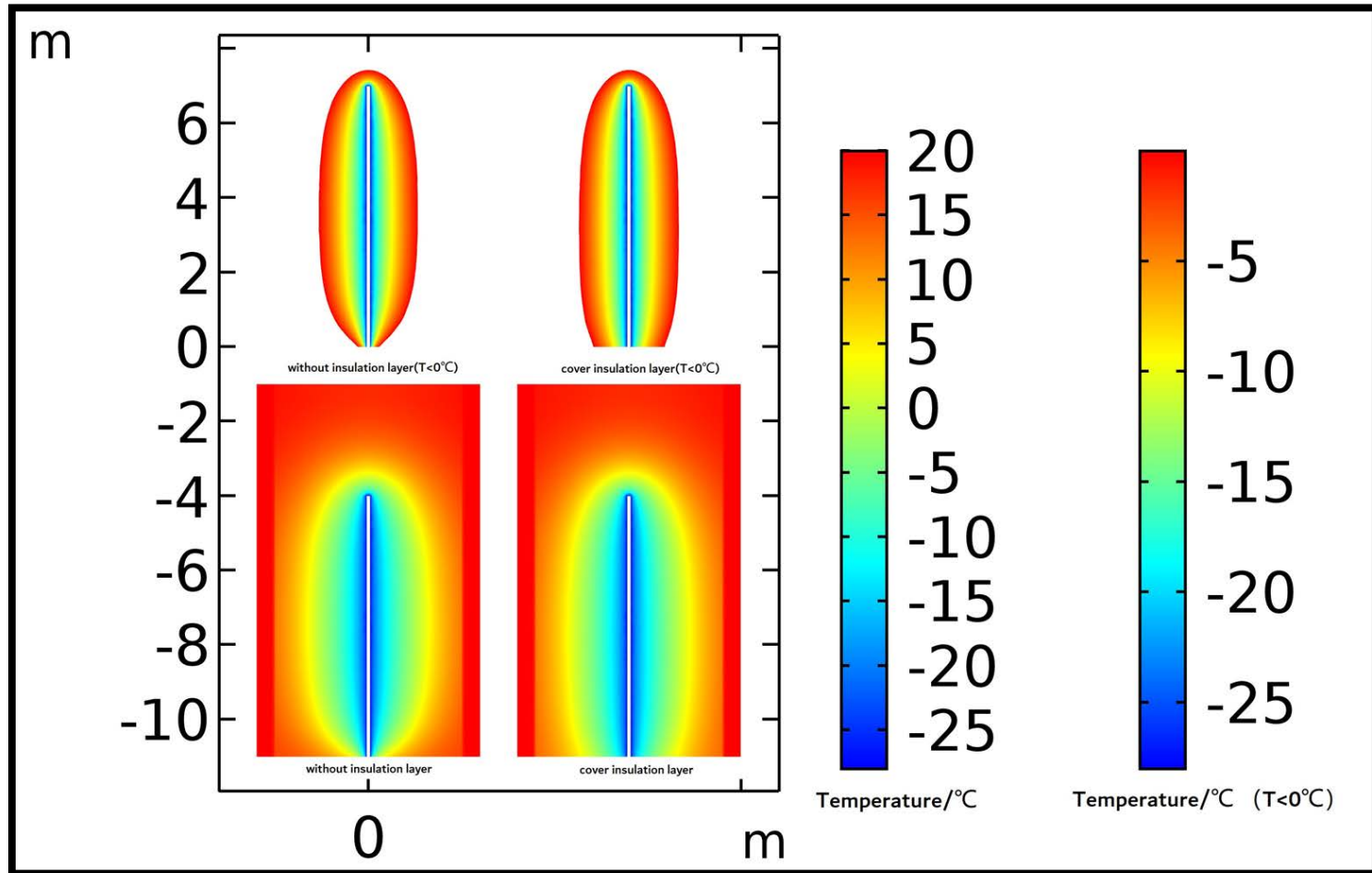

**Temperature in Different Condition**

## The function of influence coefficient with thermal insulation layer

$$\eta(x, t) = 1 - \frac{\xi(x, t)}{\xi_{max}(t)}$$

1. The influence of heat dissipation is more than 2.2m
2. Compared with different condition, the thermal insulation layer(5cm, 0.03W/m<sup>2</sup>) can reduce more than 50% heat dissipation.
3. We get the evaluation function of freezing effect.

*Thanks*

---

Boxer-cn@163.com

---